

FIGURES 1-23

ã 2010 Baingio Pinna

(in high resolution) from the article

New Gestalt Principles of Perceptual Organization: An Extension from Grouping to Shape and Meaning

By Baingio Pinna

Published in:

Gestalt Theory – An International Multidisciplinary Journal, 32 (1), March 2010, 11-78.

<http://gestalttheory.net/gth/>

This paper won the

Wolfgang Metzger Award 2009

<http://gestalttheory.net/award/>

Contact information:

Baingio Pinna
Department of Architecture, Design and Urban Planning
Palazzo del Pou Salit
Piazza Duomo 6
University of Sassari
I-07041 ALGHERO
Italy
Email: baingio@uniss.it

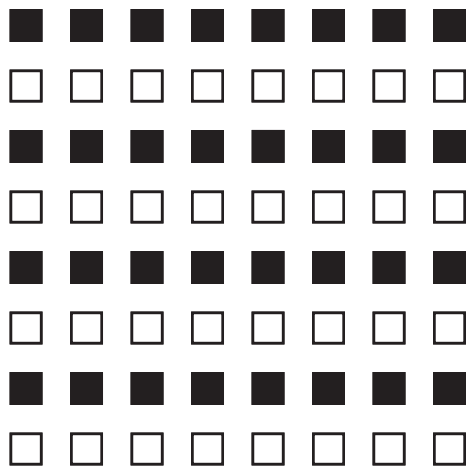

a

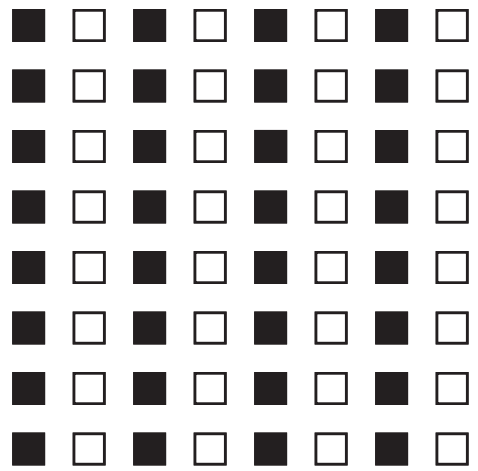

b

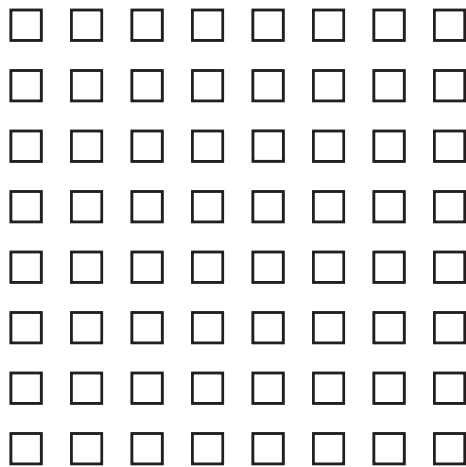

c

Figure 1. *Baingio Pinna*

Beyond the Gestalt principles of perceptual organization: The forms of grouping, shape and meaning



a

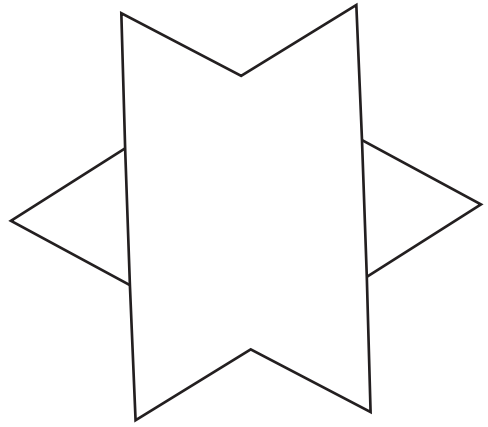

b

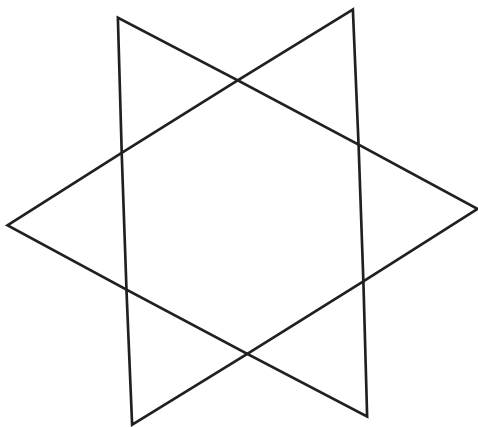

c

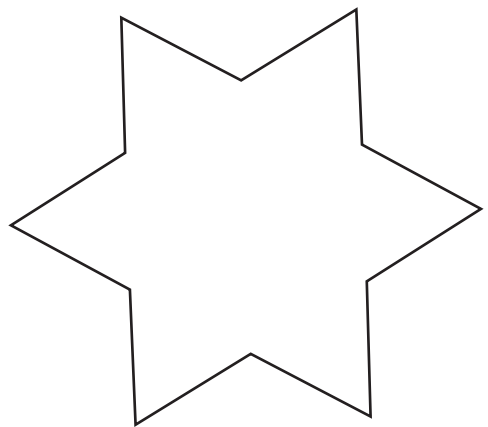

d

Figure 2. *Baingio Pinna*

Beyond the Gestalt principles of perceptual organization: The forms of grouping, shape and meaning

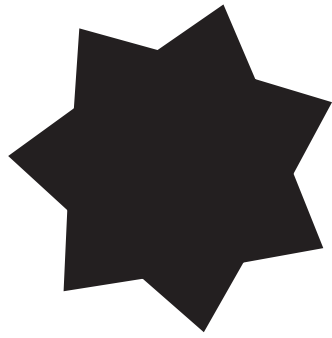

a

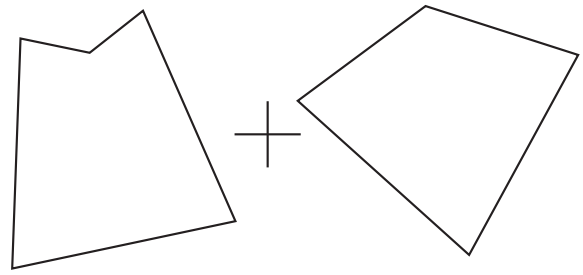

b

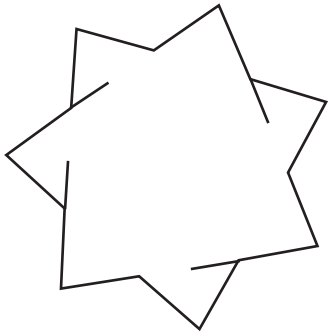

c



d

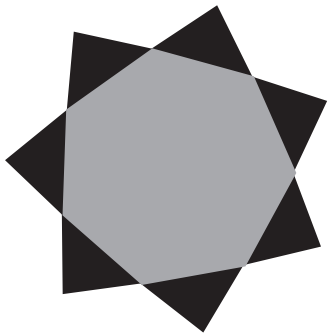

e

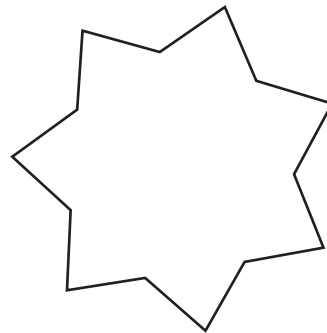

f

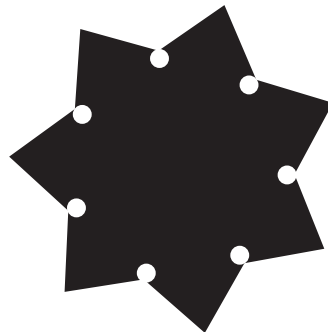

g

Figure 3. *Baingio Pinna*

Beyond the Gestalt principles of perceptual organization: The forms of grouping, shape and meaning

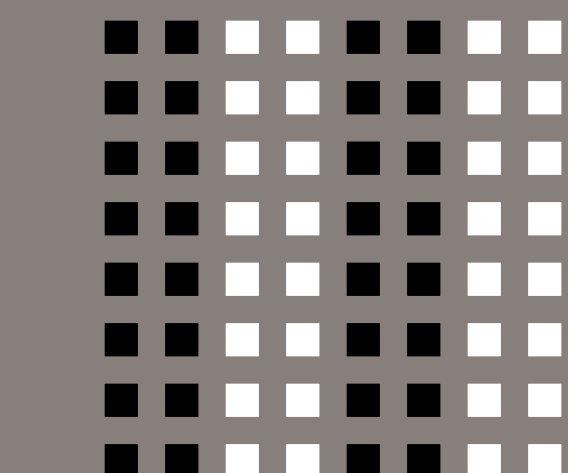
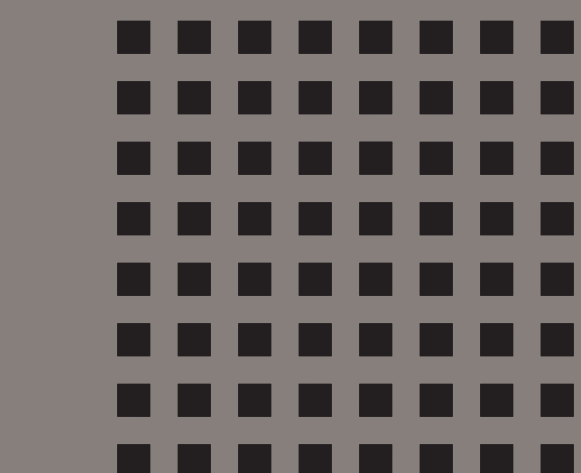
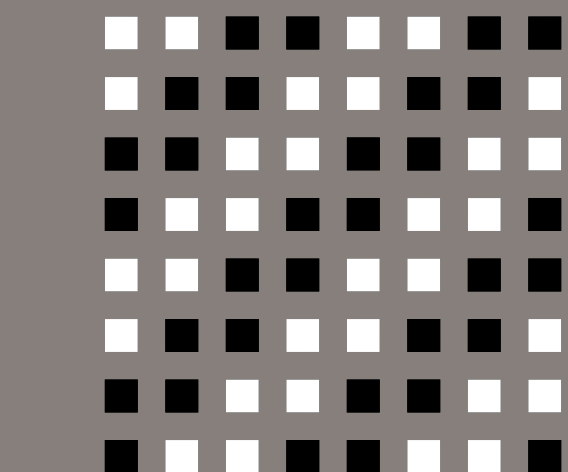
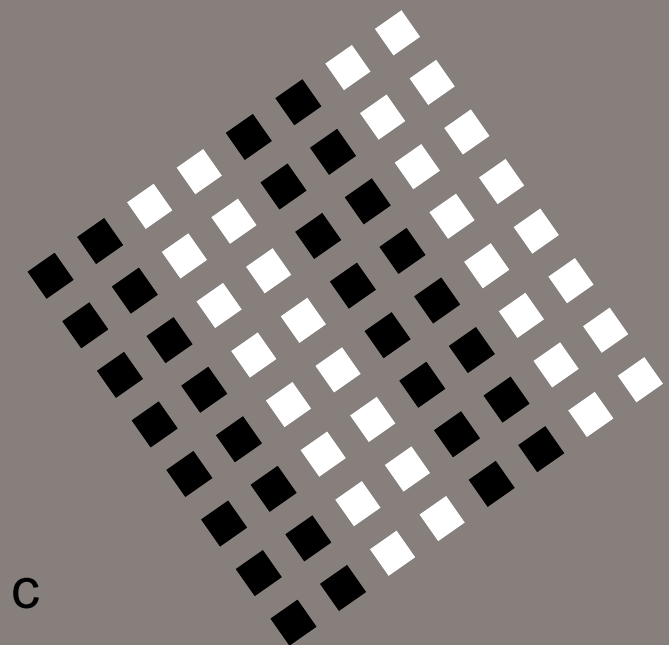
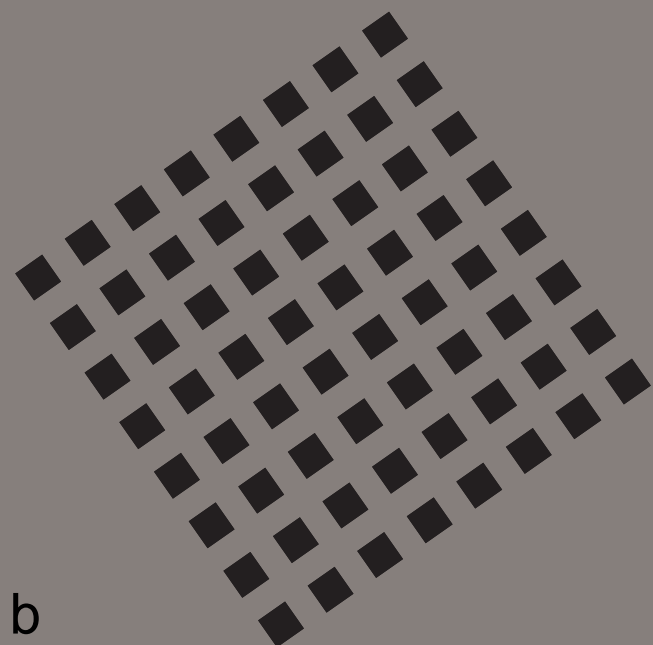
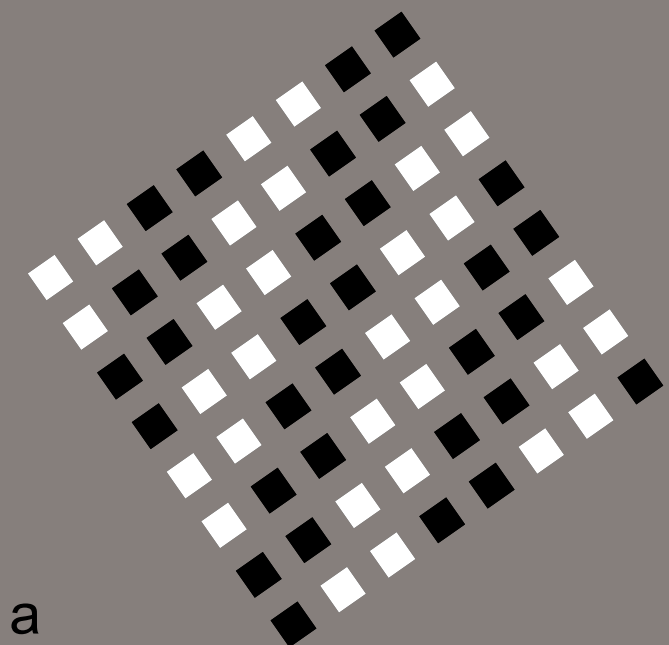

Figure 4. *Baingio Pinna*

Beyond the Gestalt principles of perceptual organization: The forms of grouping, shape and meaning

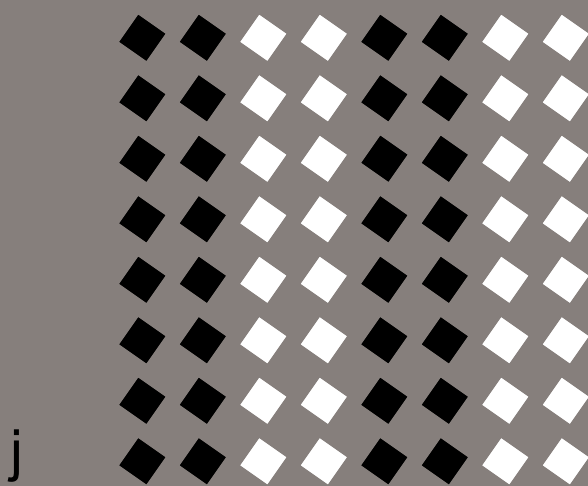
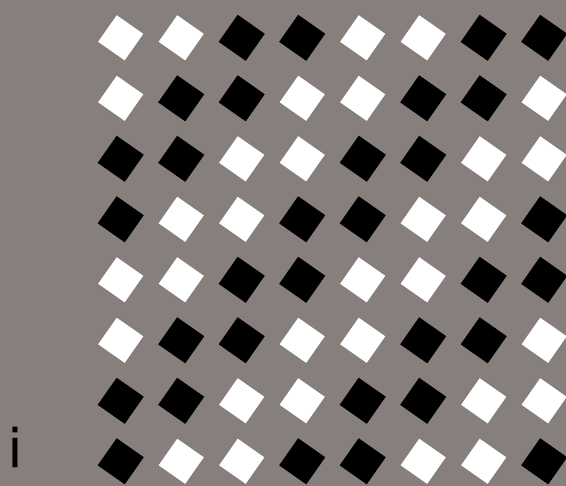
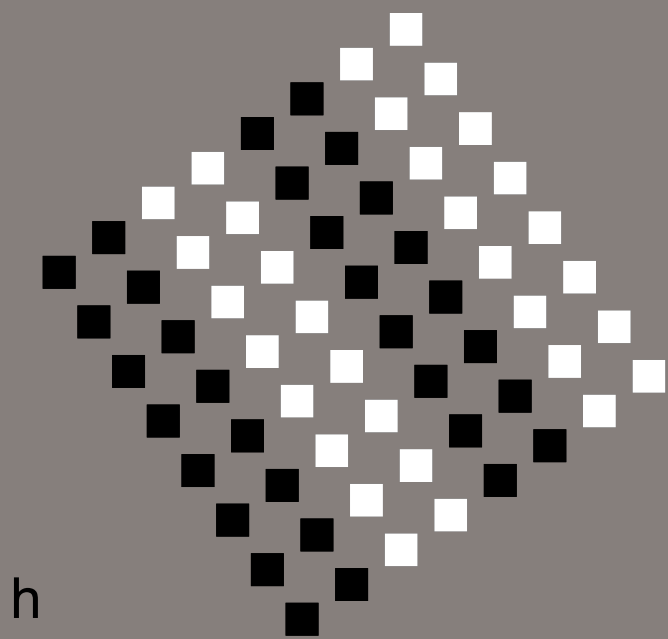
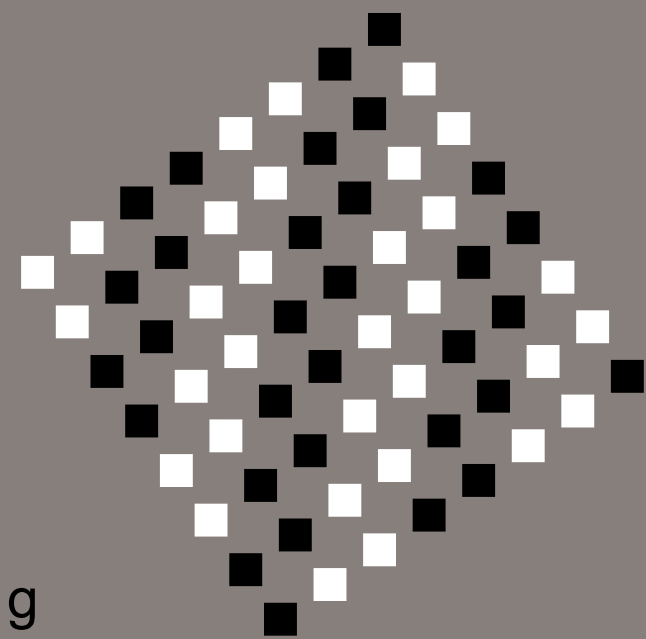

Figure 4. *Baingio Pinna*

Beyond the Gestalt principles of perceptual organization: The forms of grouping, shape and meaning

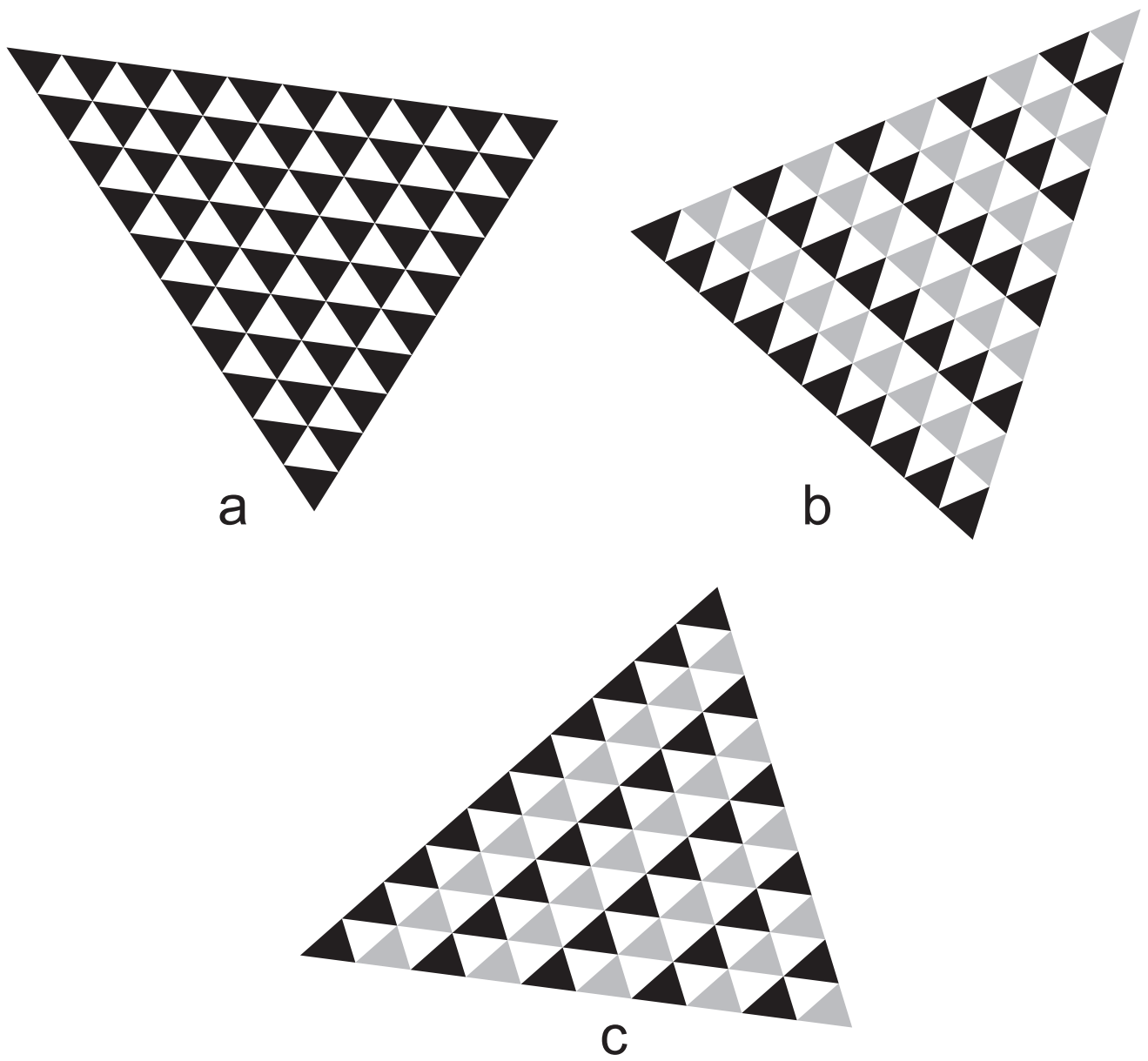

Figure 5. *Baingio Pinna*

Beyond the Gestalt principles of perceptual organization: The forms of grouping, shape and meaning

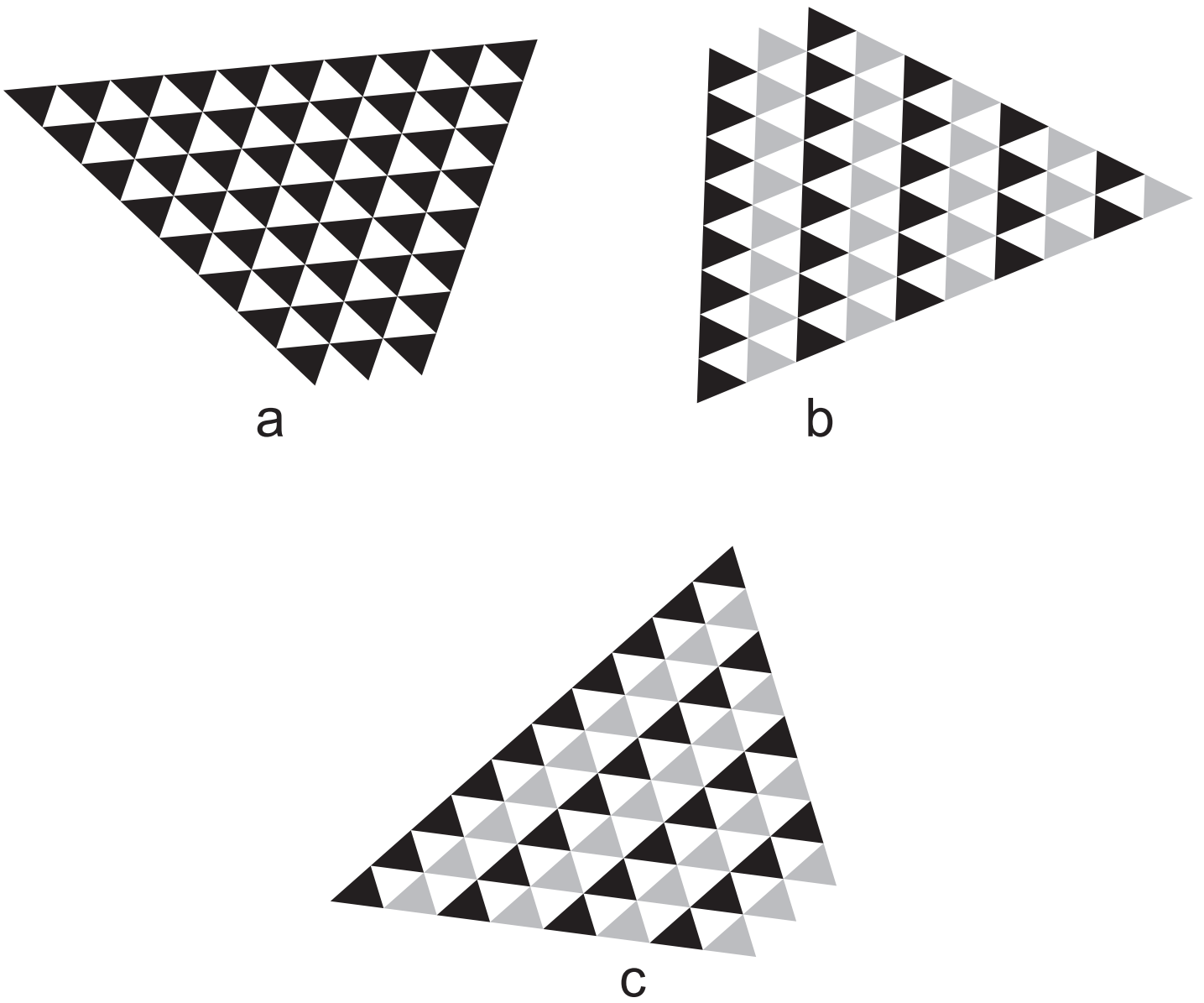
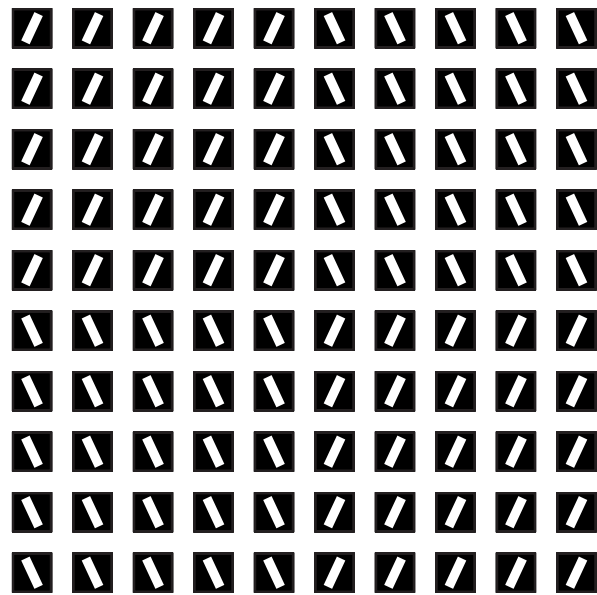
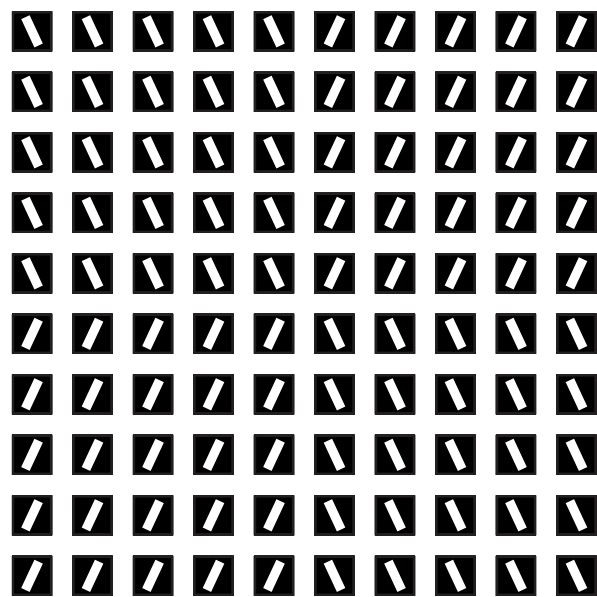

Figure 6. *Baingio Pinna*

Beyond the Gestalt principles of perceptual organization: The forms of grouping, shape and meaning



a



b

Figure 7. *Baingio Pinna*

Beyond the Gestalt principles of perceptual organization: The forms of grouping, shape and meaning



a

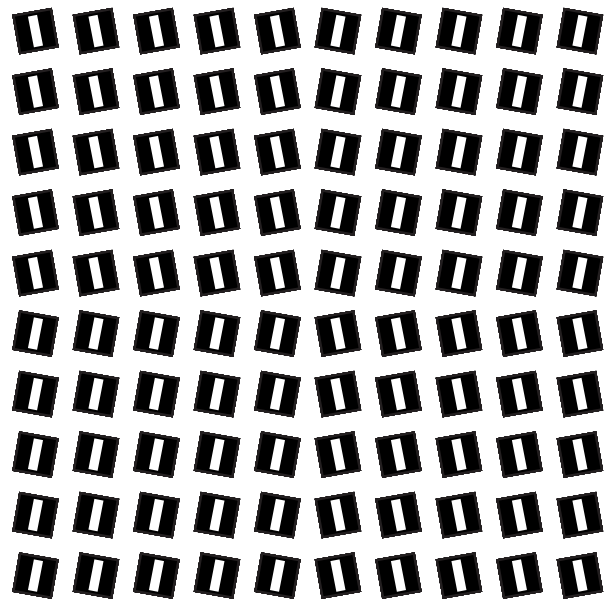

b

Figure 8. *Baingio Pinna*

Beyond the Gestalt principles of perceptual organization: The forms of grouping, shape and meaning

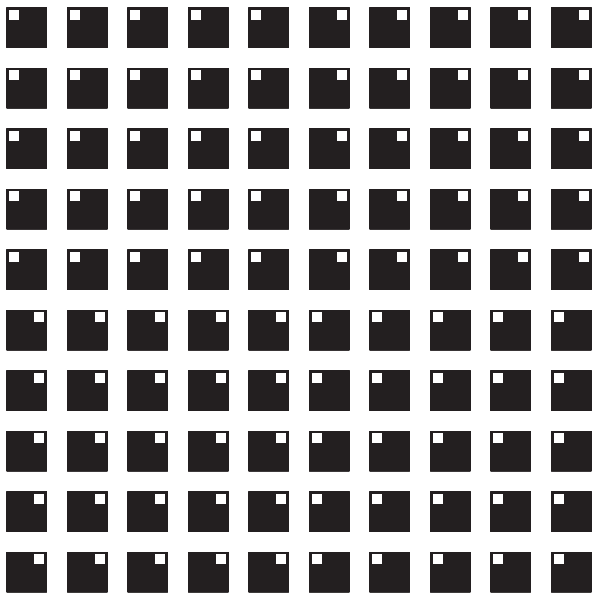

a

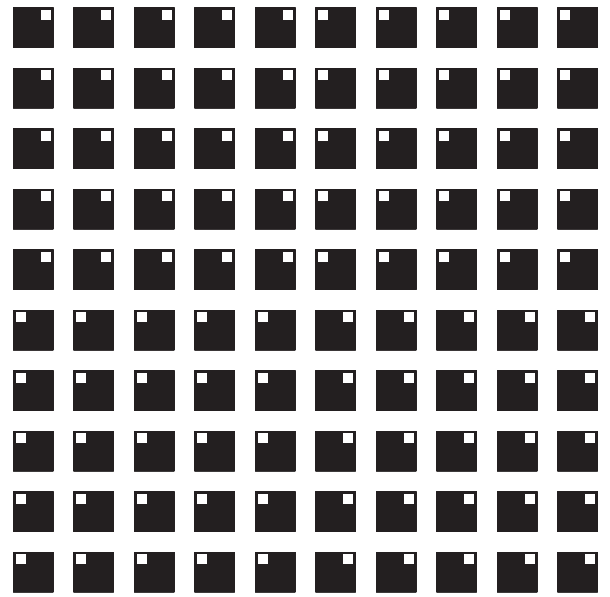

b

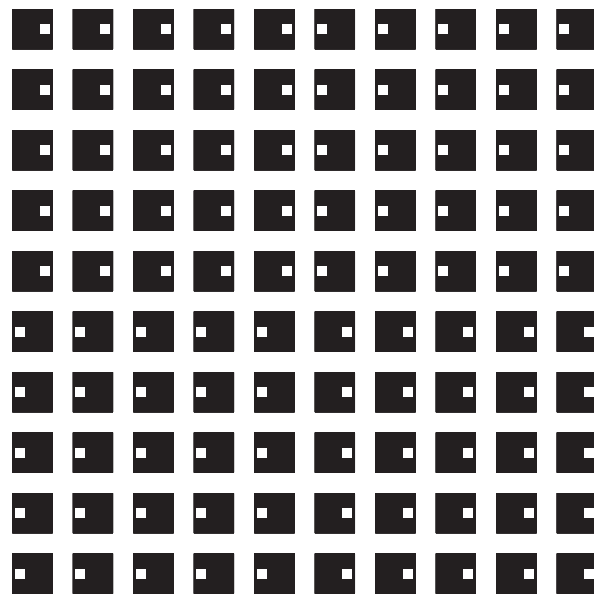

c

Figure 9. *Baingio Pinna*

Beyond the Gestalt principles of perceptual organization: The forms of grouping, shape and meaning

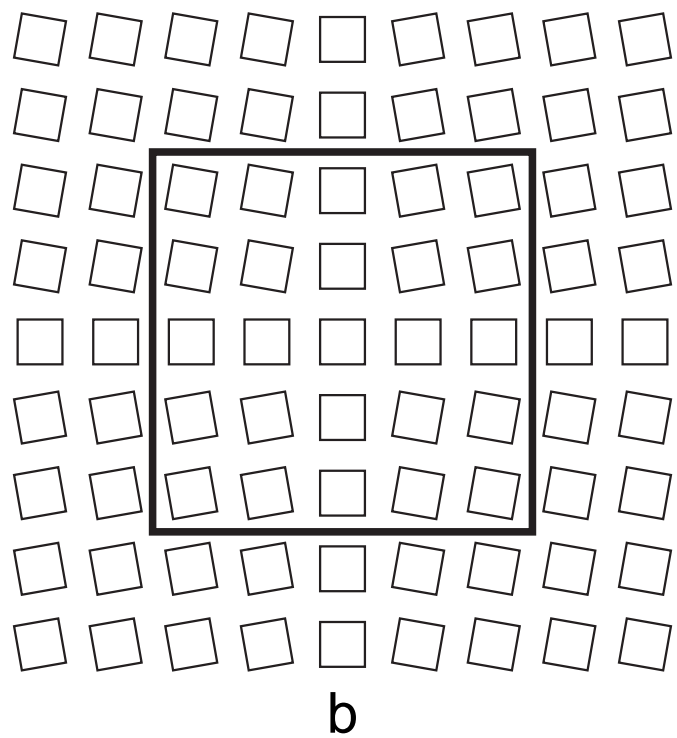
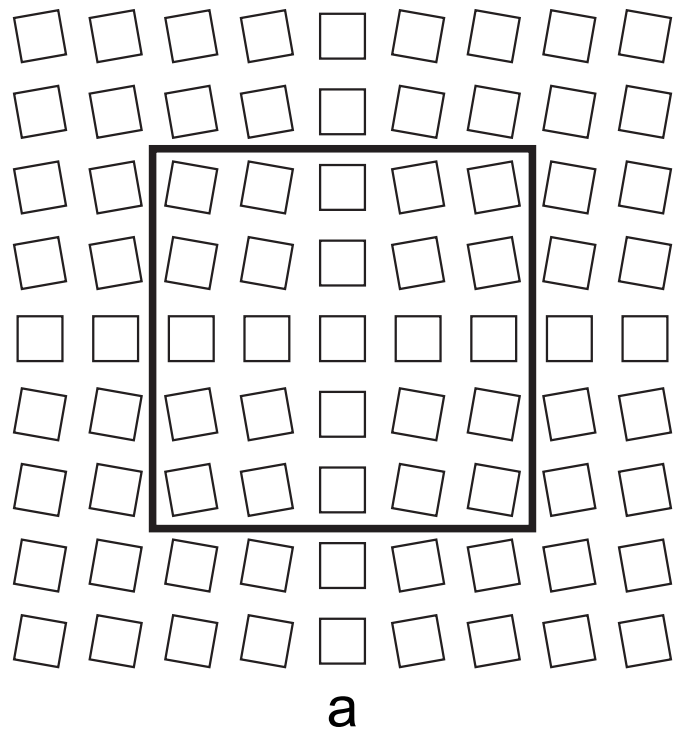
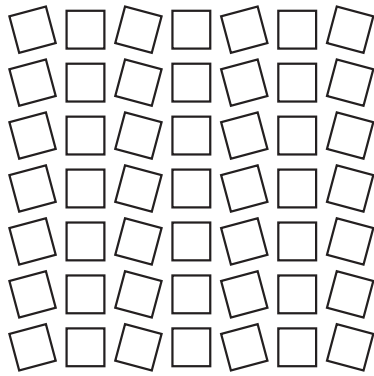
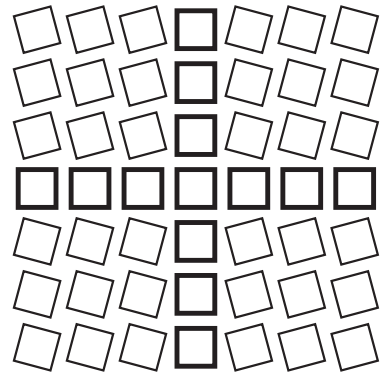

Figure 10. *Baingio Pinna*

Beyond the Gestalt principles of perceptual organization: The forms of grouping, shape and meaning



a



b

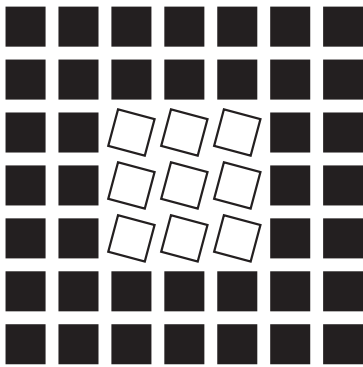

c

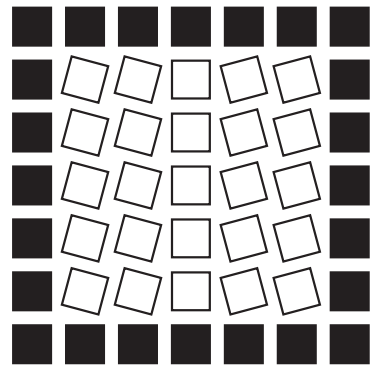

d

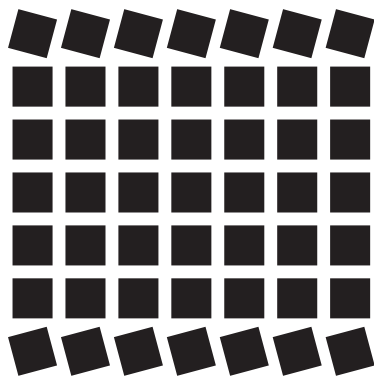

e

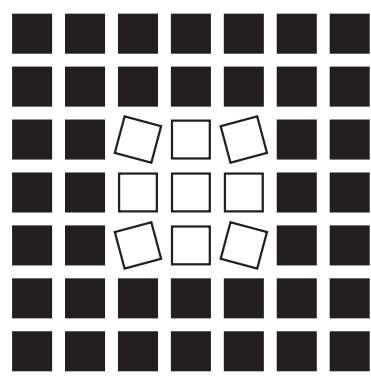

f

Figure 11. *Baingio Pinna*

Beyond the Gestalt principles of perceptual organization: The forms of grouping, shape and meaning

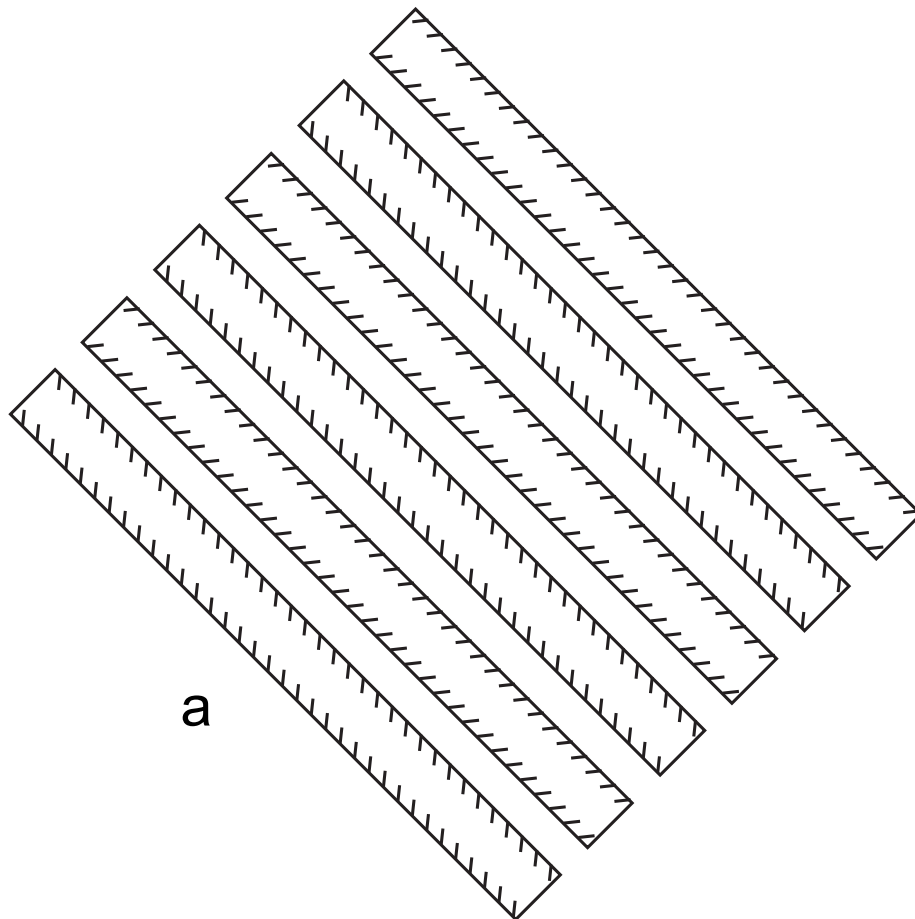

a

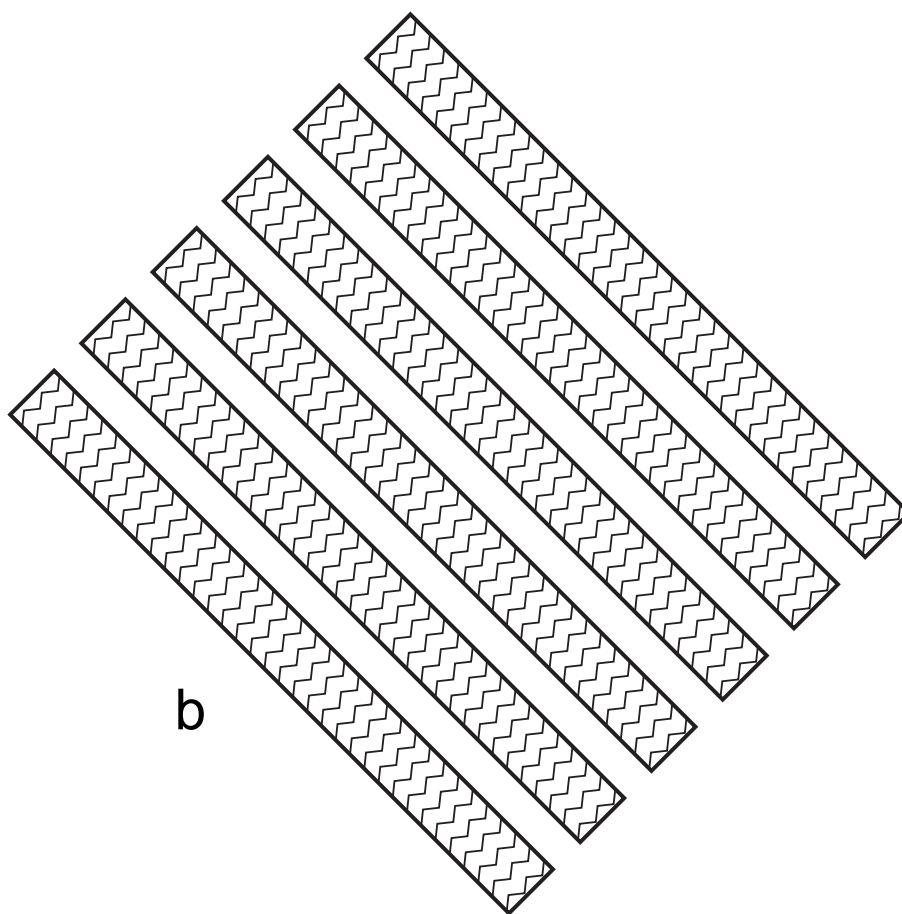

b

Figure 12. *Baingio Pinna*

Beyond the Gestalt principles of perceptual organization: The forms of grouping, shape and meaning

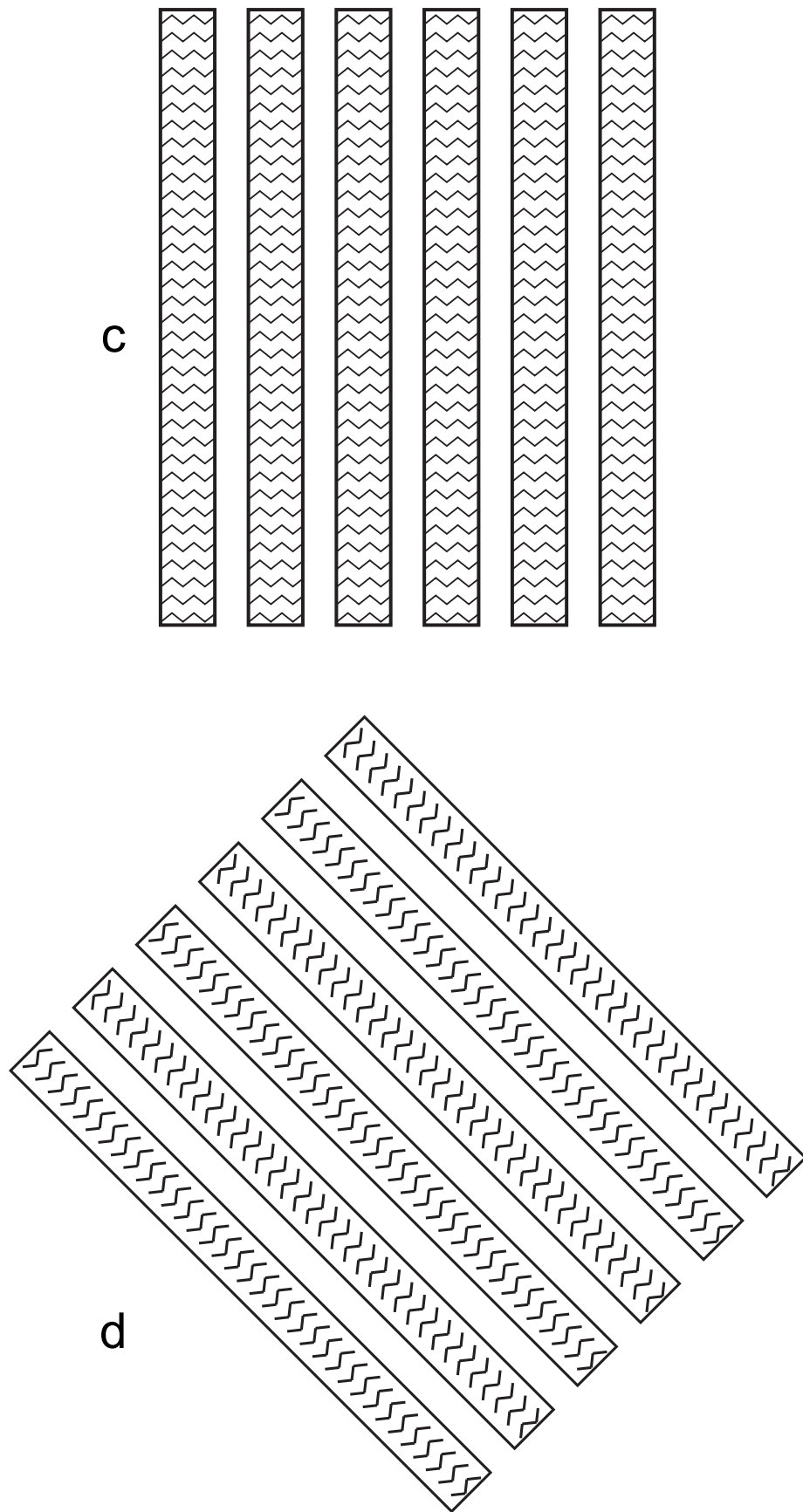

Figure 12. *Baingio Pinna*

Beyond the Gestalt principles of perceptual organization: The forms of grouping, shape and meaning

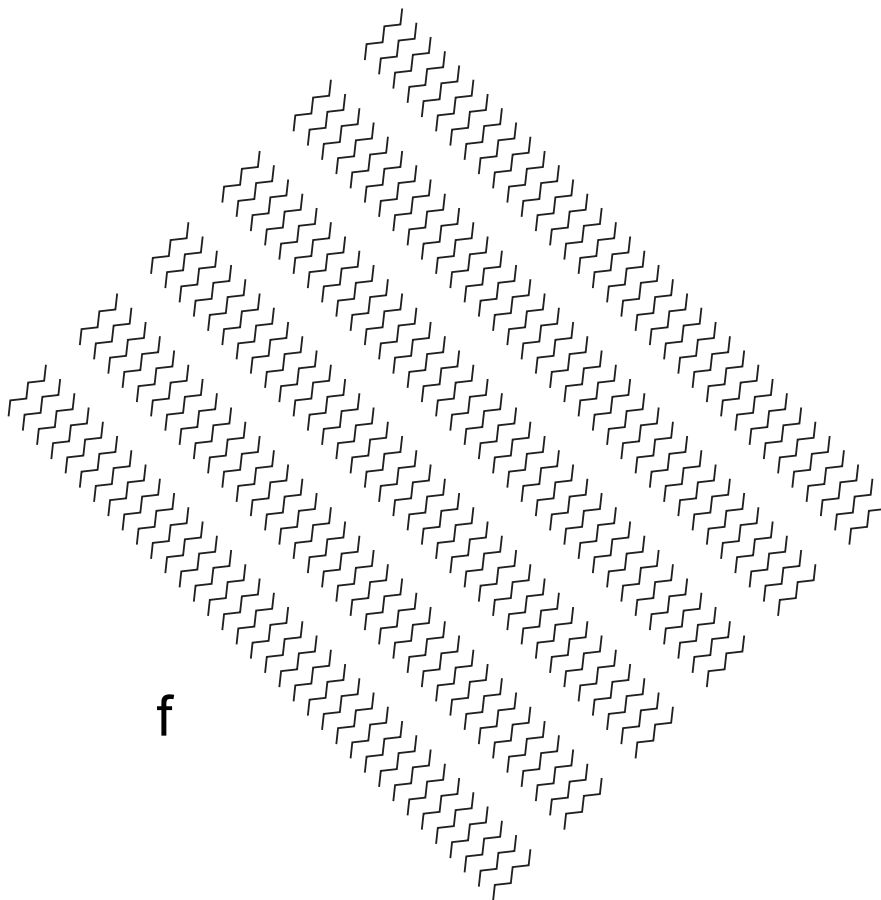
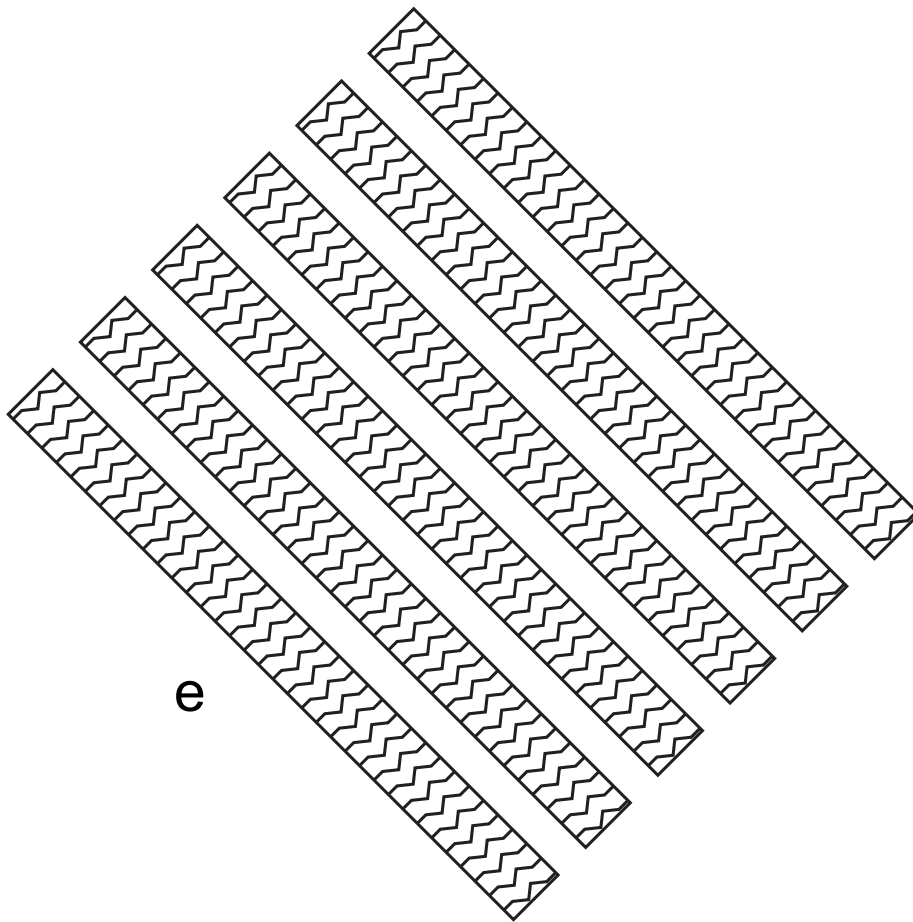
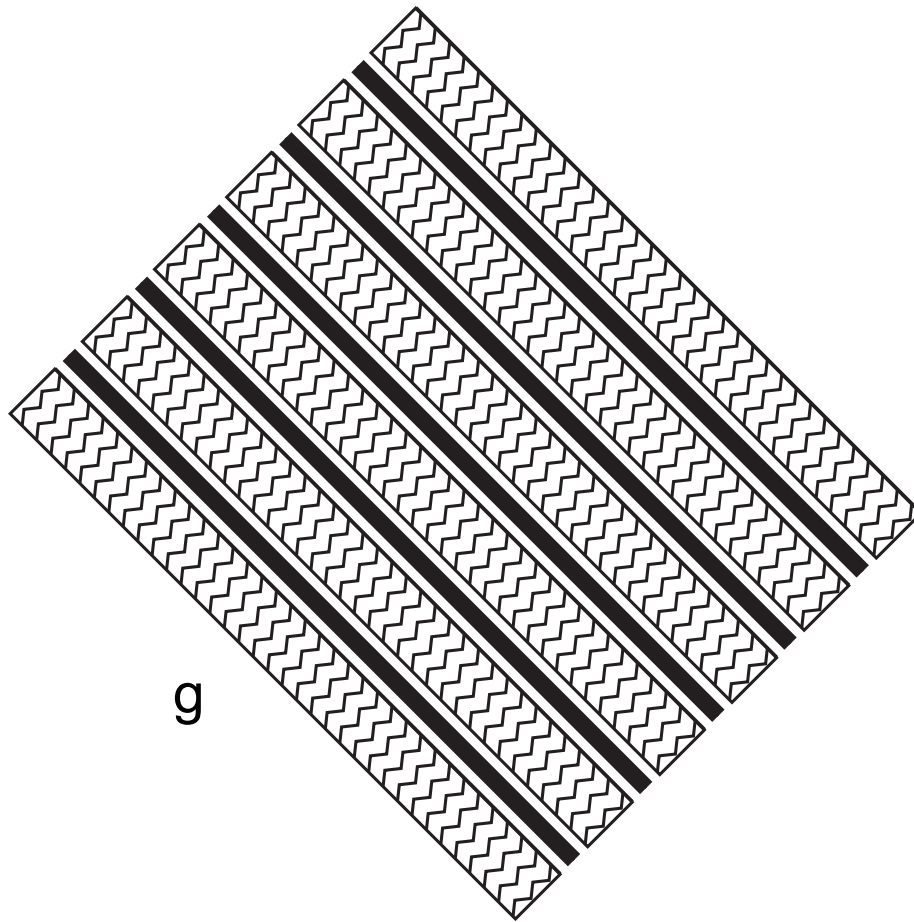
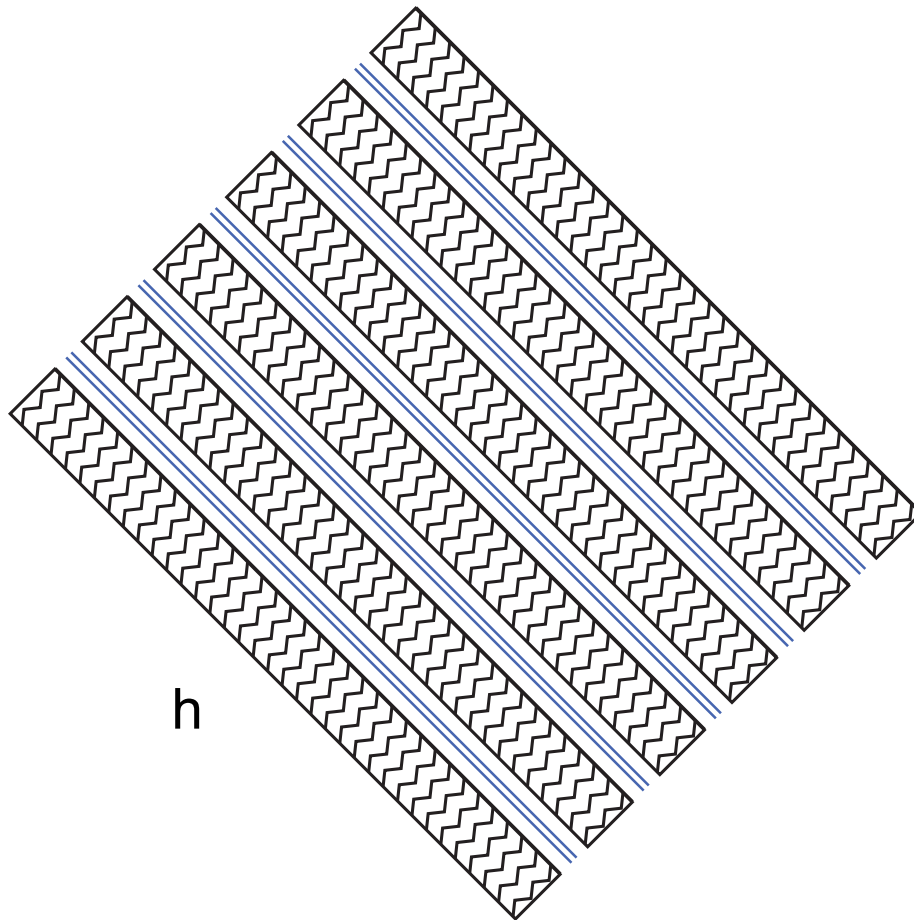

Figure 12. *Baingio Pinna*

Beyond the Gestalt principles of perceptual organization: The forms of grouping, shape and meaning



g



h

Figure 12. *Baingio Pinna*

Beyond the Gestalt principles of perceptual organization: The forms of grouping, shape and meaning

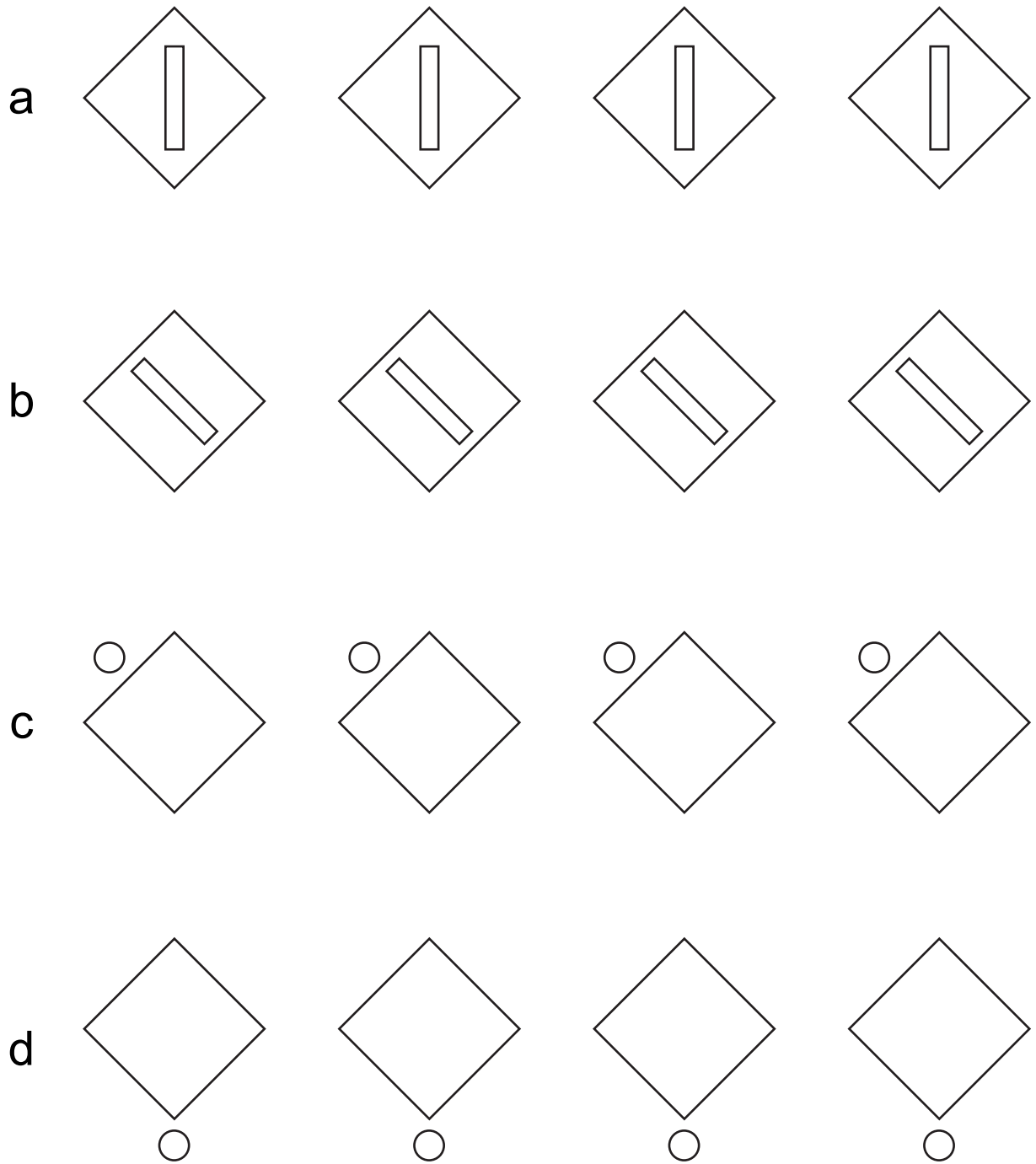

Figure 13. *Baingio Pinna*

Beyond the Gestalt principles of perceptual organization: The forms of grouping, shape and meaning

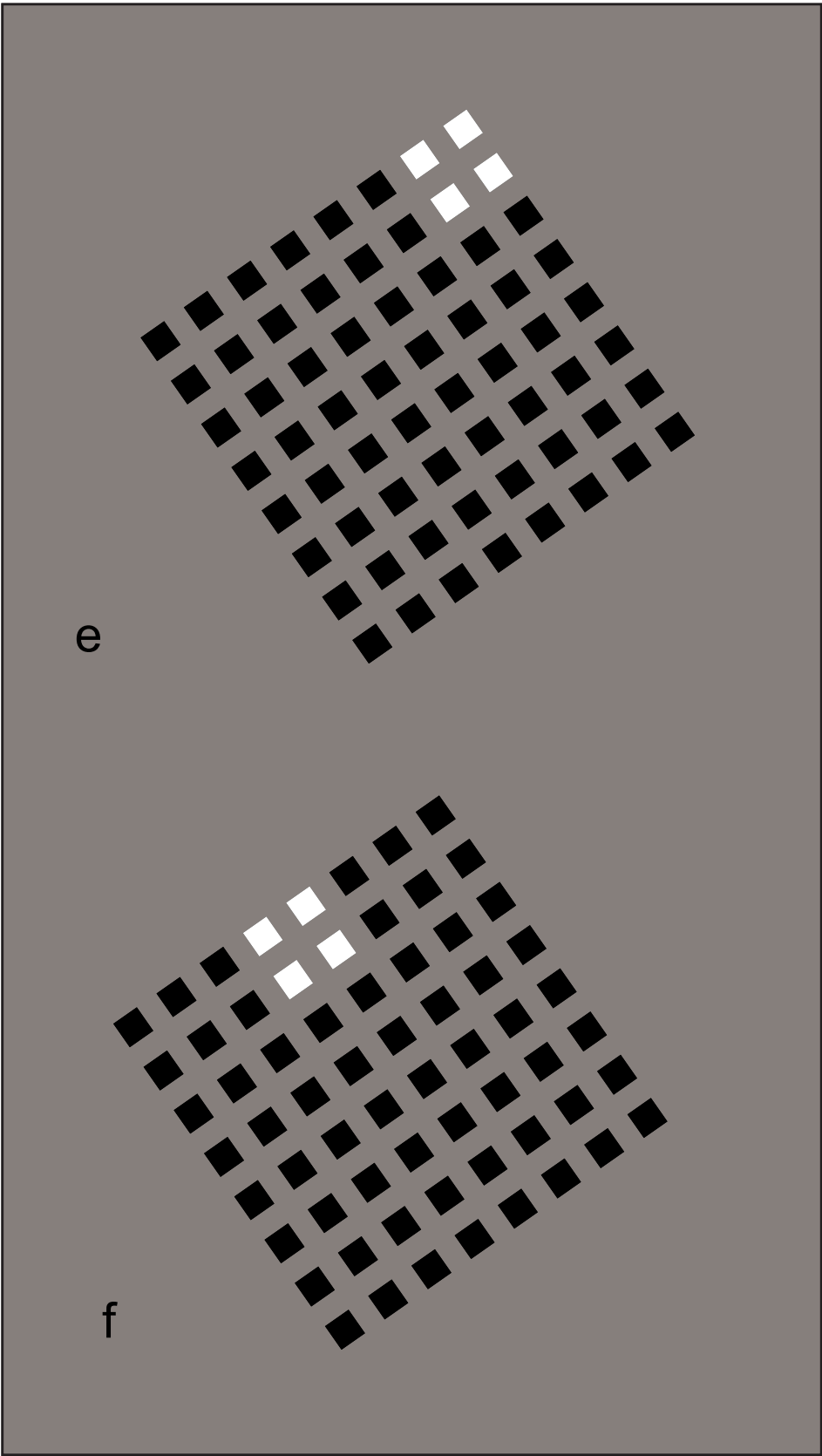

Figure 13. *Baingio Pinna*

Beyond the Gestalt principles of perceptual organization: The forms of grouping, shape and meaning

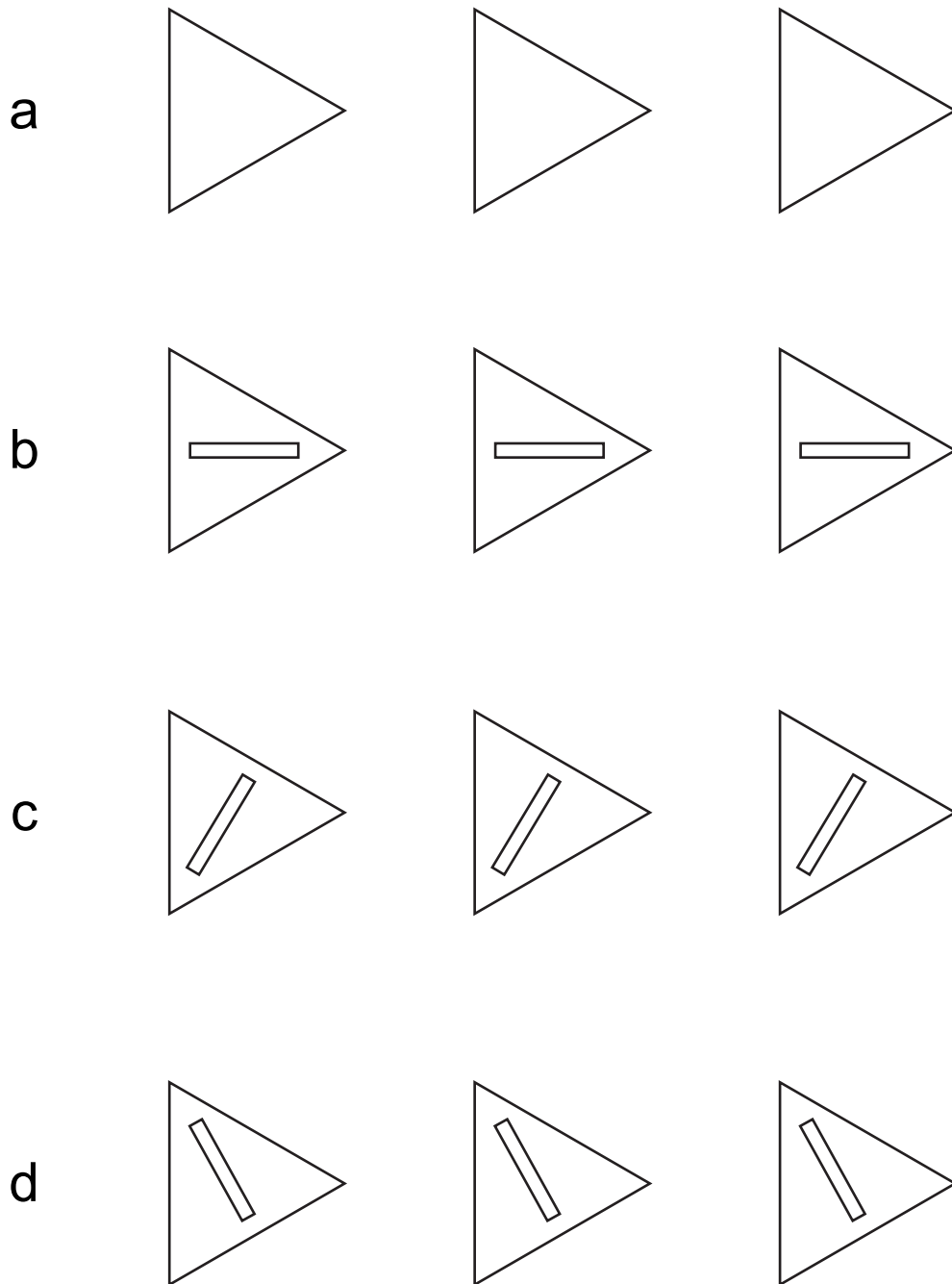

Figure 14. *Baingio Pinna*

Beyond the Gestalt principles of perceptual organization: The forms of grouping, shape and meaning

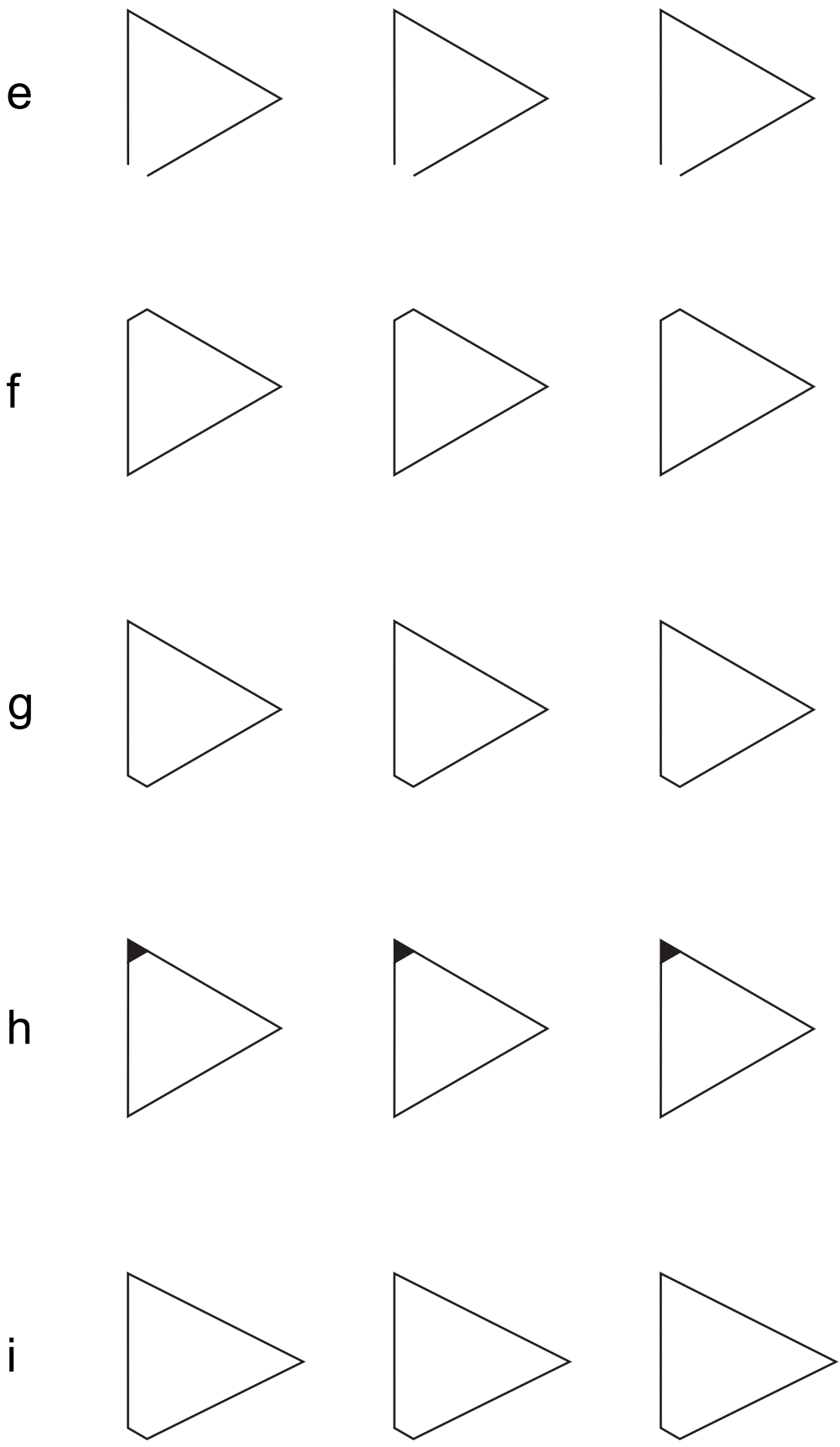

Figure 14. *Baingio Pinna*

Beyond the Gestalt principles of perceptual organization: The forms of grouping, shape and meaning

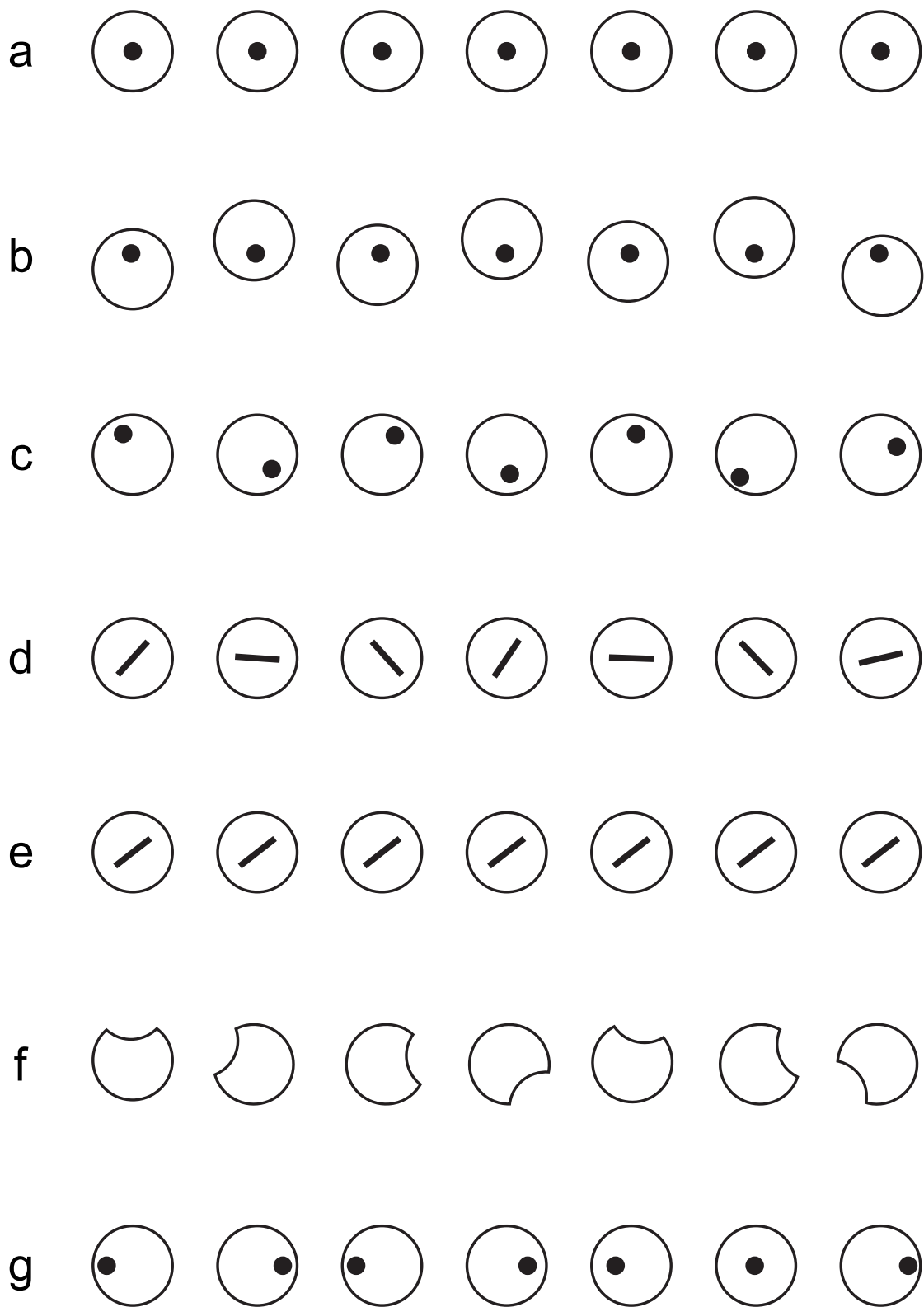
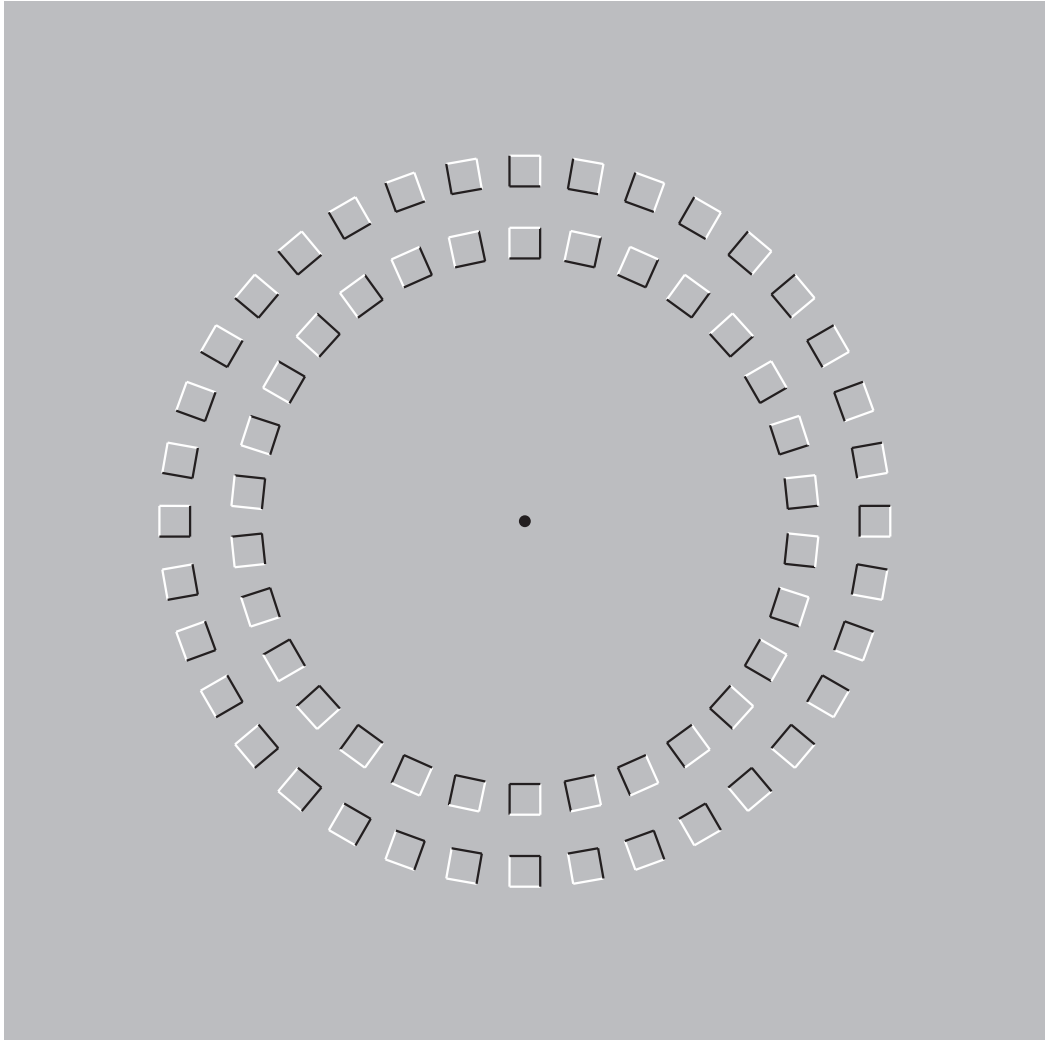

Figure 15. *Baingio Pinna*

Beyond the Gestalt principles of perceptual organization: The forms of grouping, shape and meaning



a

Figure 16. *Baingio Pinna*

Beyond the Gestalt principles of perceptual organization: The forms of grouping, shape and meaning

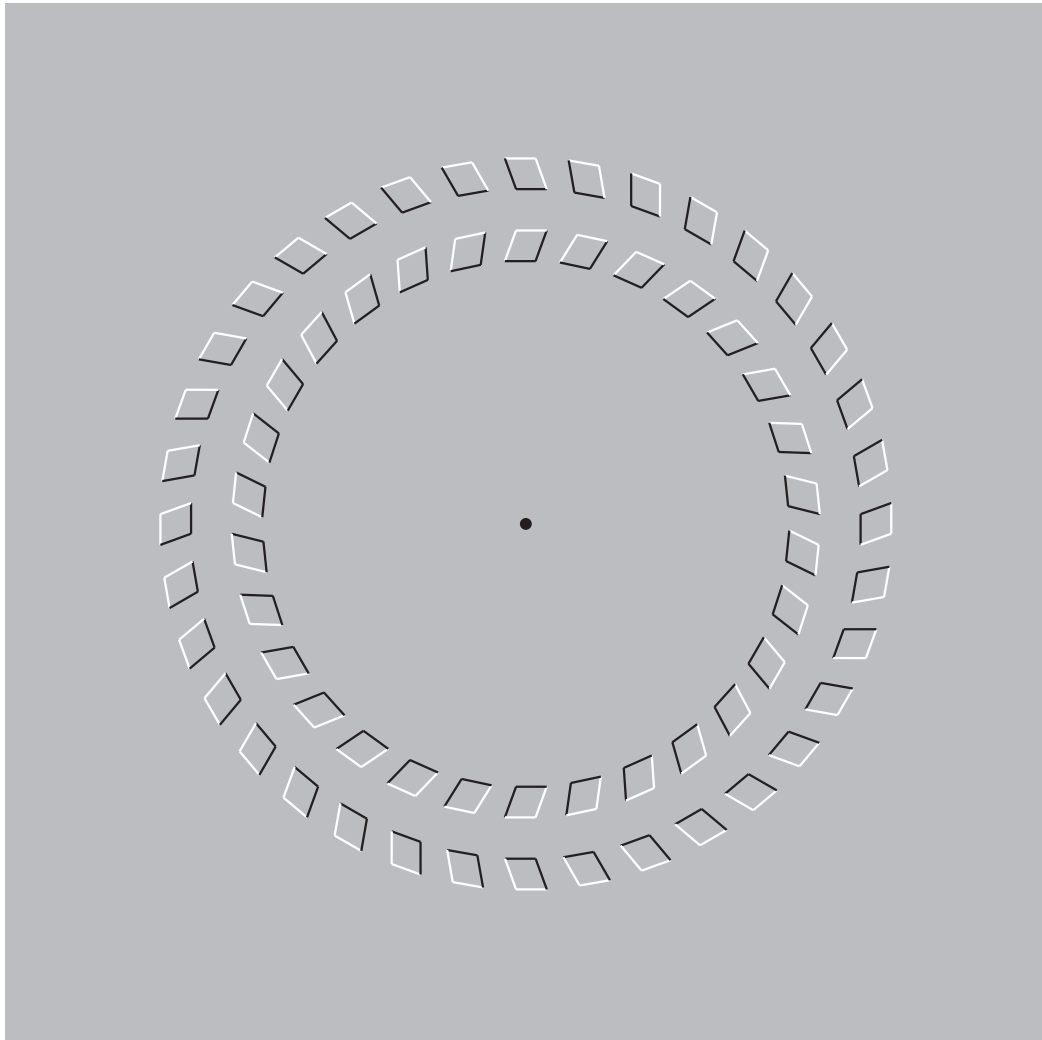

b

Figure 16. *Baingio Pinna*

Beyond the Gestalt principles of perceptual organization: The forms of grouping, shape and meaning

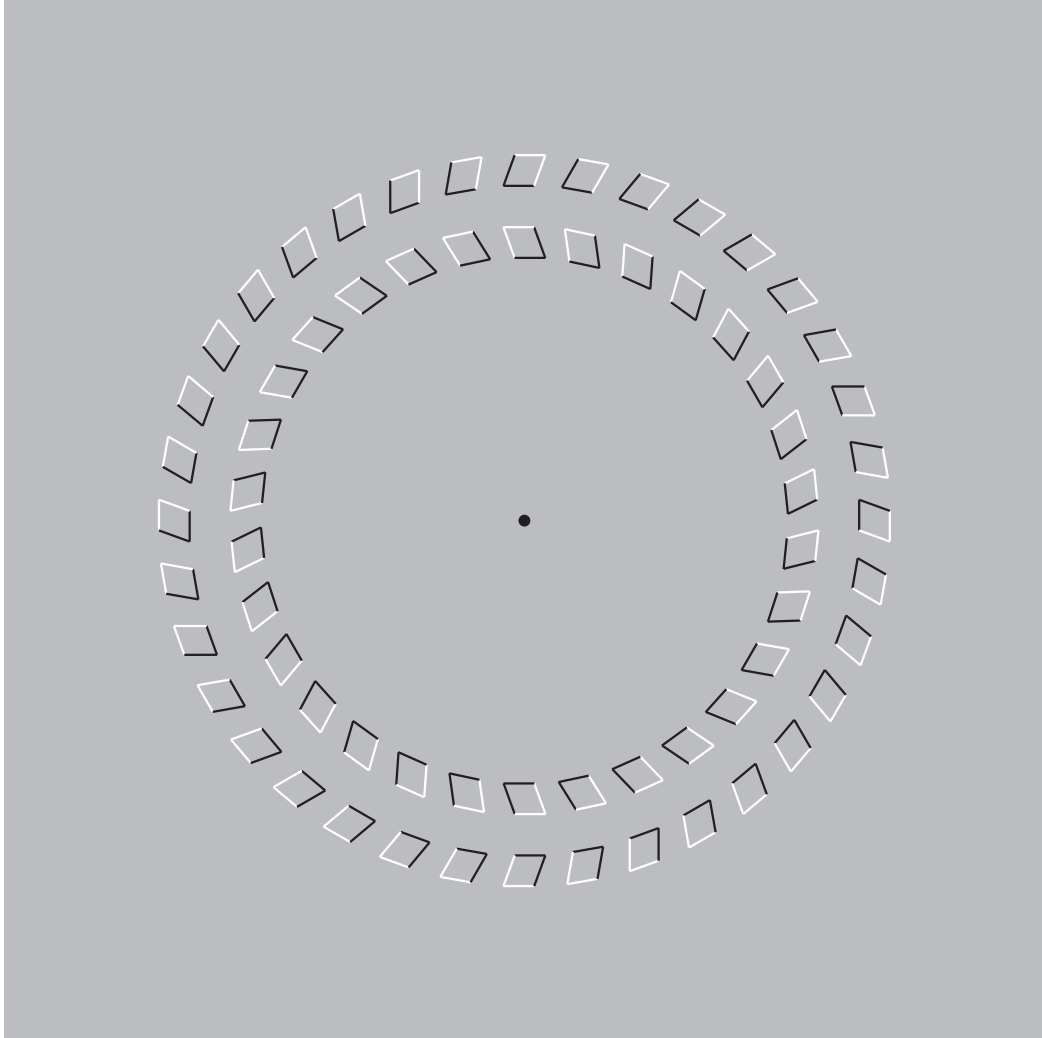

C

Figure 16. *Baingio Pinna*

Beyond the Gestalt principles of perceptual organization: The forms of grouping, shape and meaning

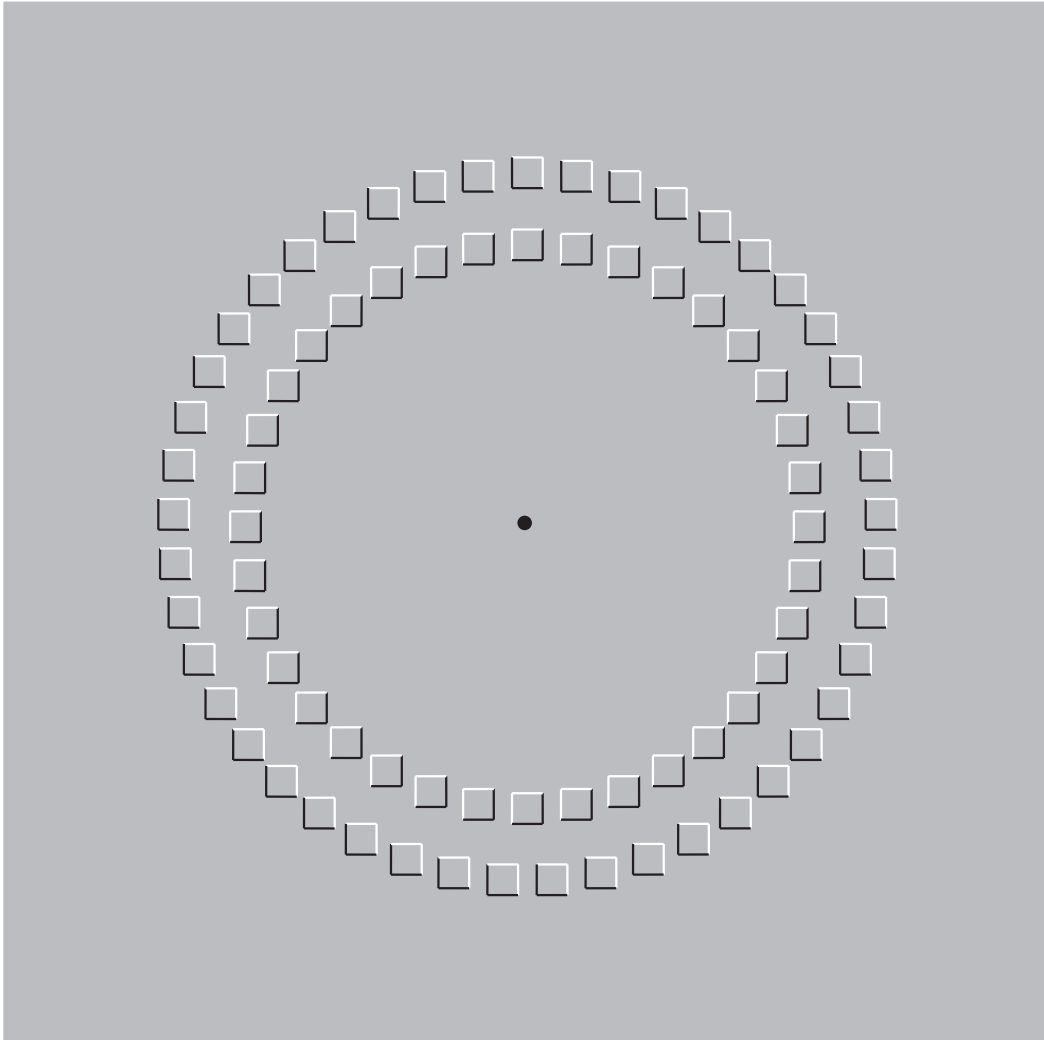

d

Figure 16. *Baingio Pinna*

Beyond the Gestalt principles of perceptual organization: The forms of grouping, shape and meaning

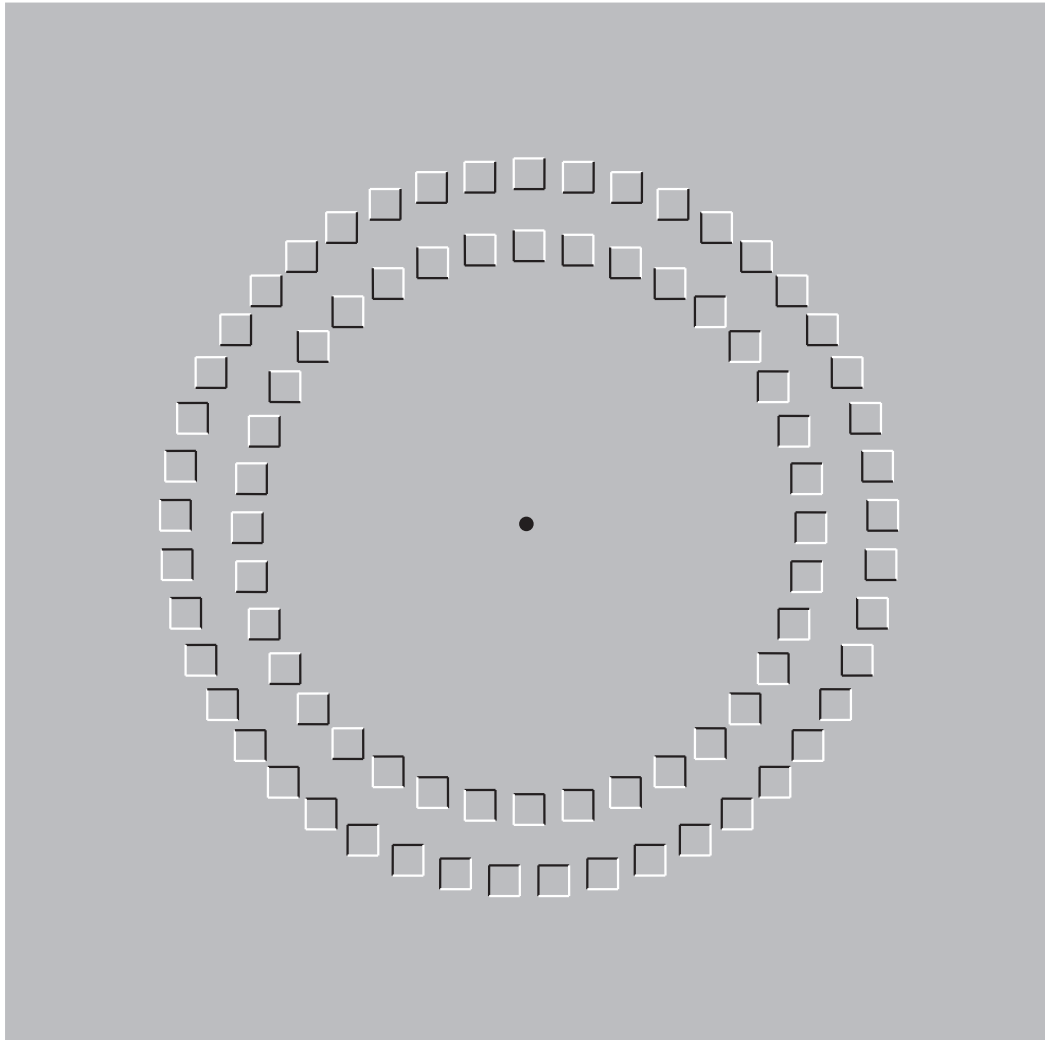

e

Figure 16. *Baingio Pinna*

Beyond the Gestalt principles of perceptual organization: The forms of grouping, shape and meaning

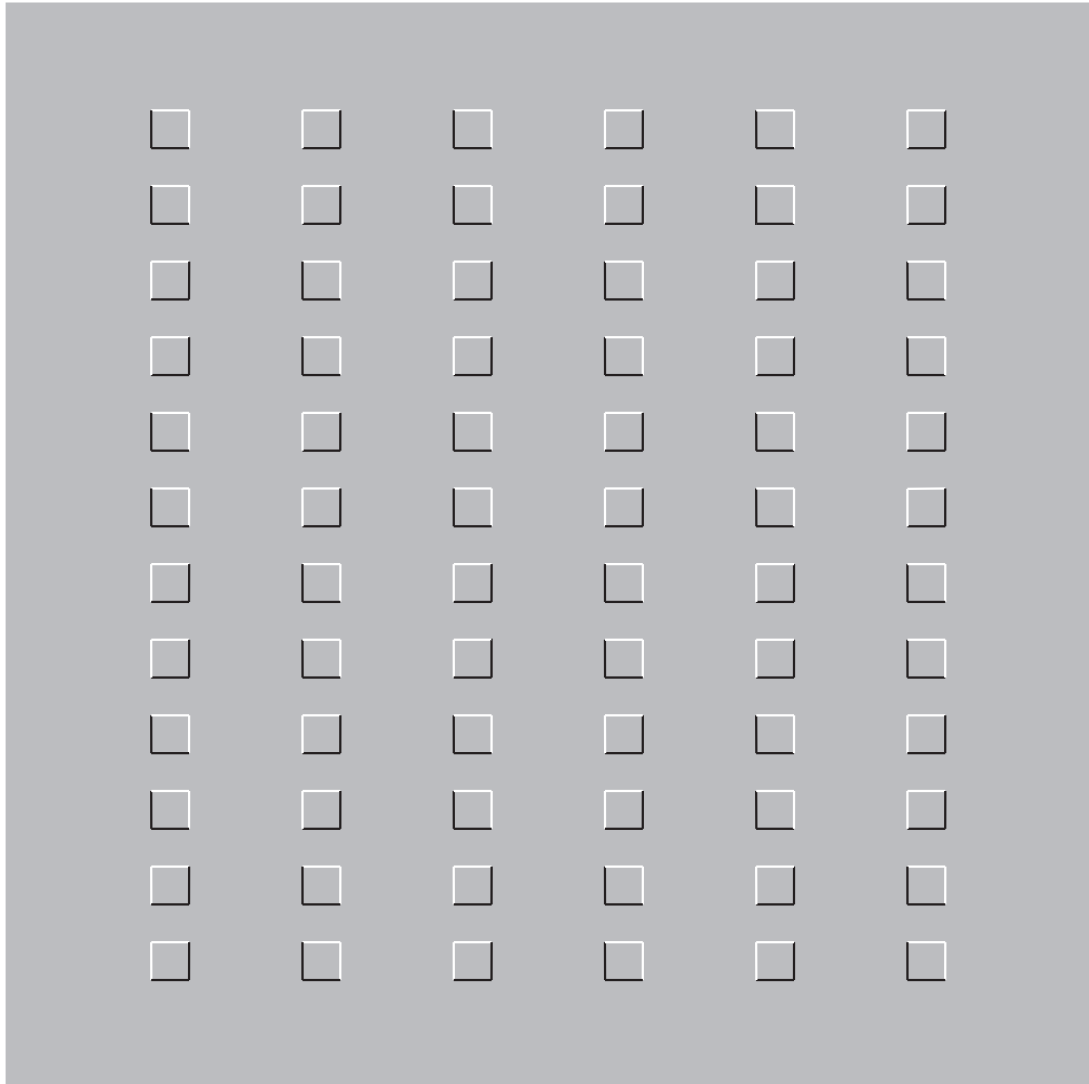

f

Figure 16. *Baingio Pinna*

Beyond the Gestalt principles of perceptual organization: The forms of grouping, shape and meaning

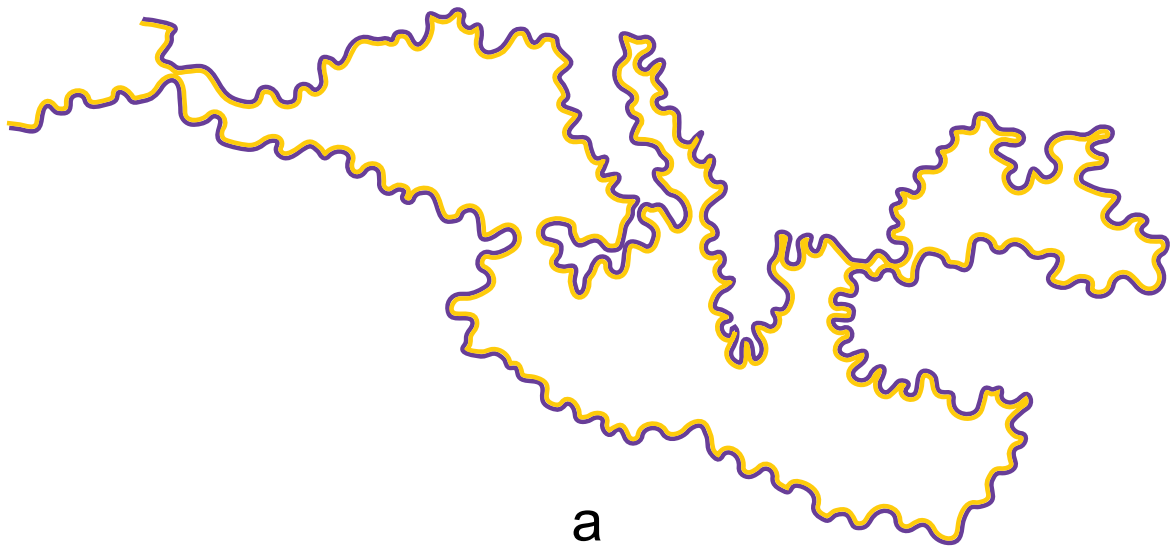

a

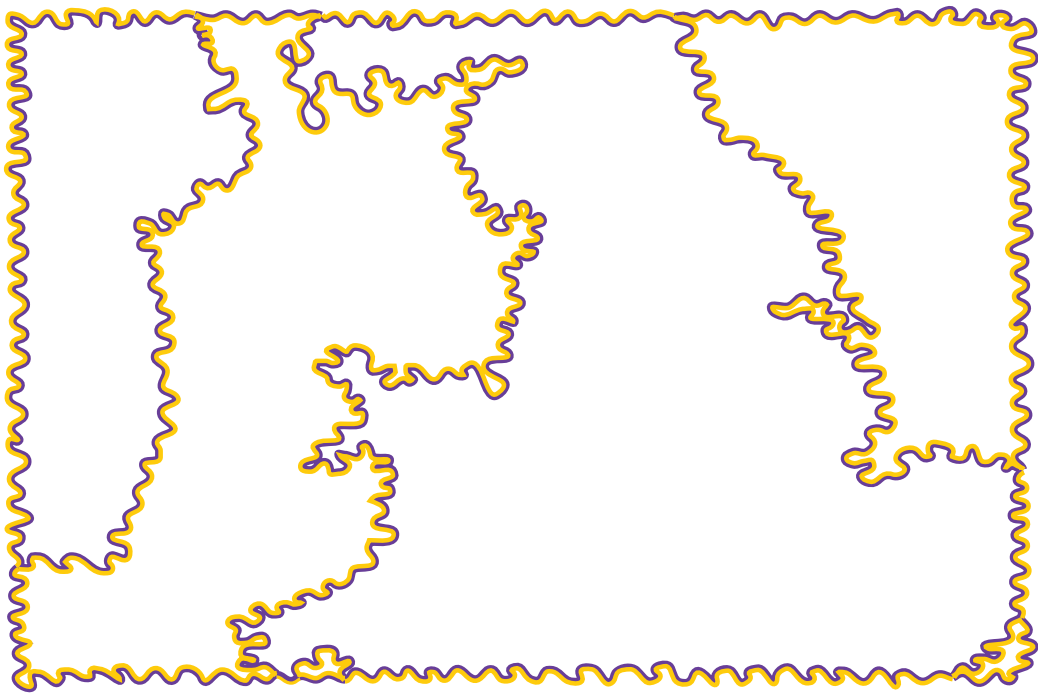

b

Figure 17. *Baingio Pinna*

Beyond the Gestalt principles of perceptual organization: The forms of grouping, shape and meaning

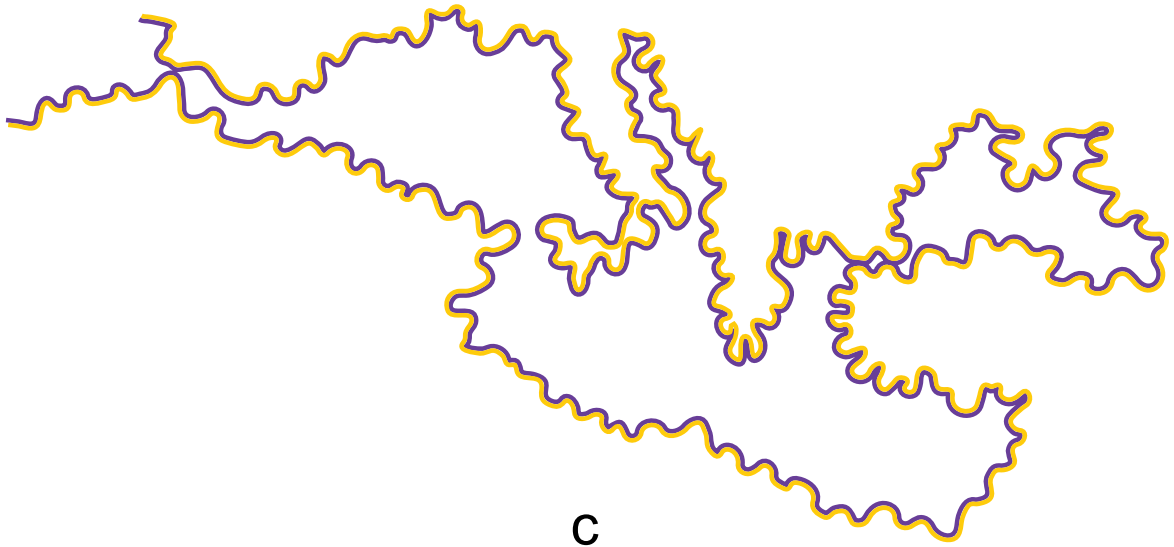

c

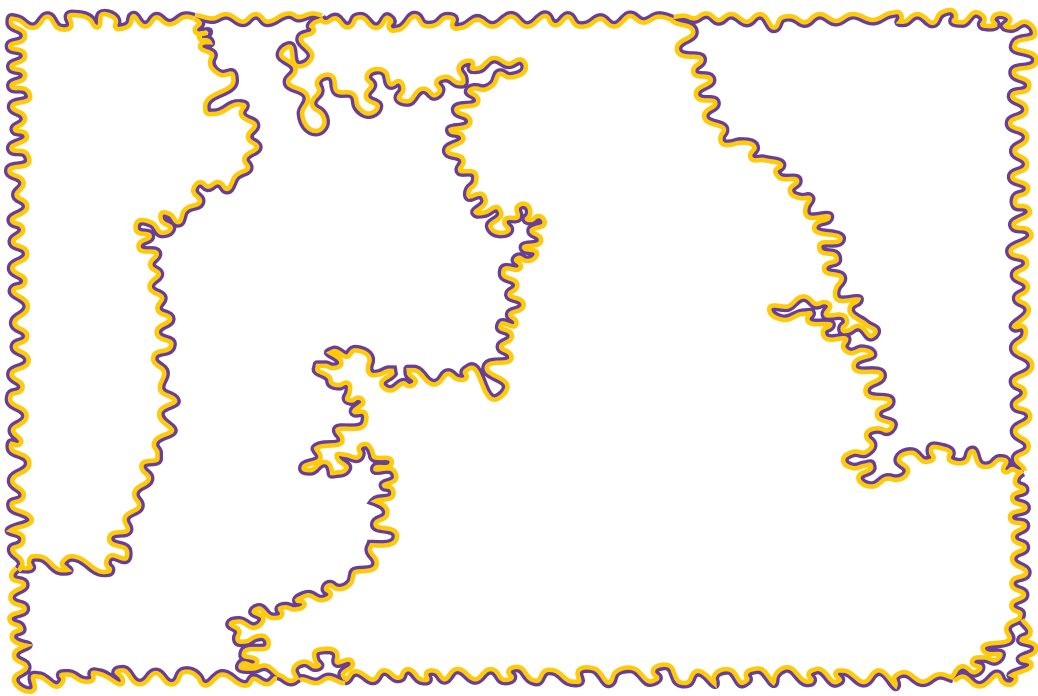

d

Figure 17. *Baingio Pinna*

Beyond the Gestalt principles of perceptual organization: The forms of grouping, shape and meaning

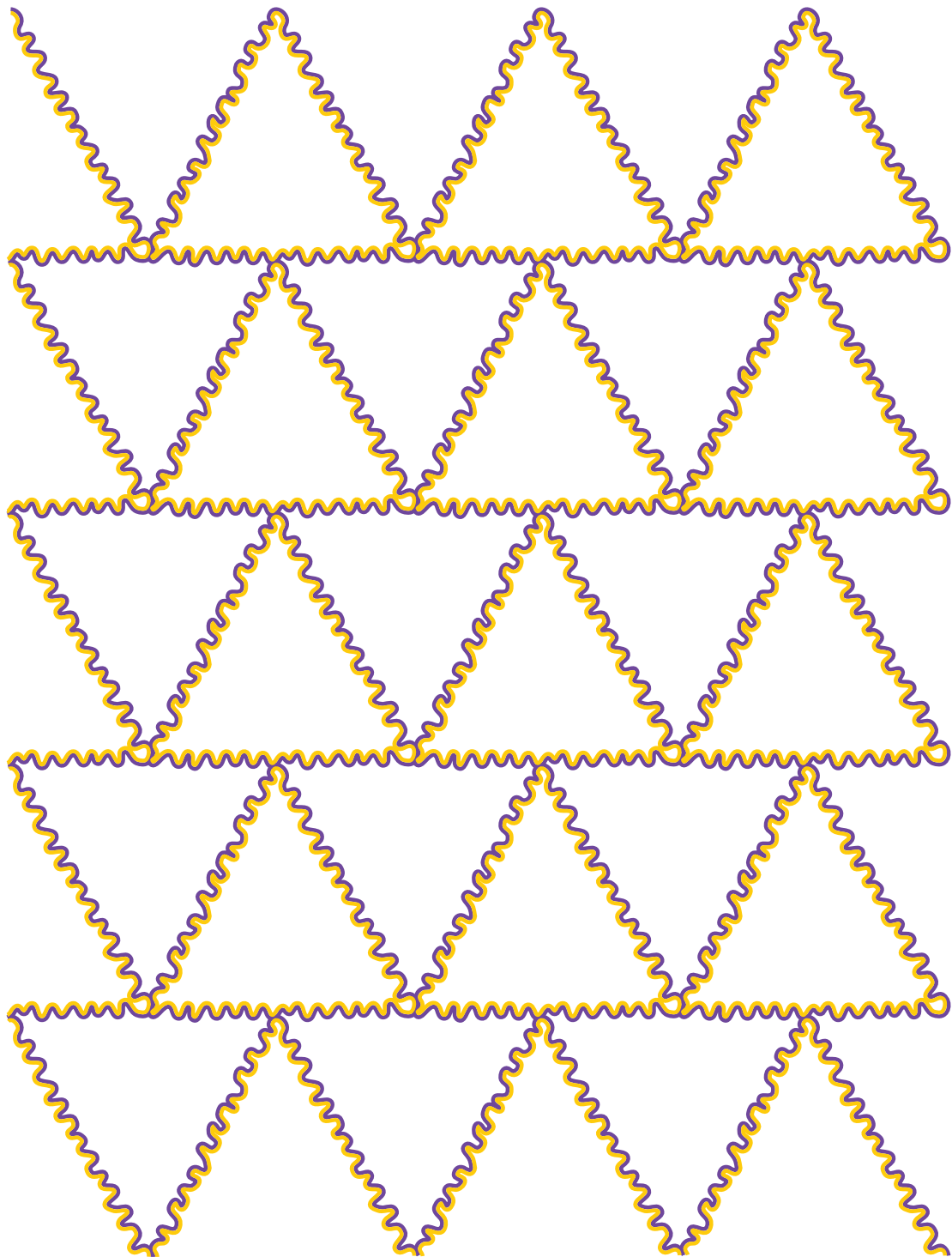

e

Figure 17. *Baingio Pinna*

Beyond the Gestalt principles of perceptual organization: The forms of grouping, shape and meaning

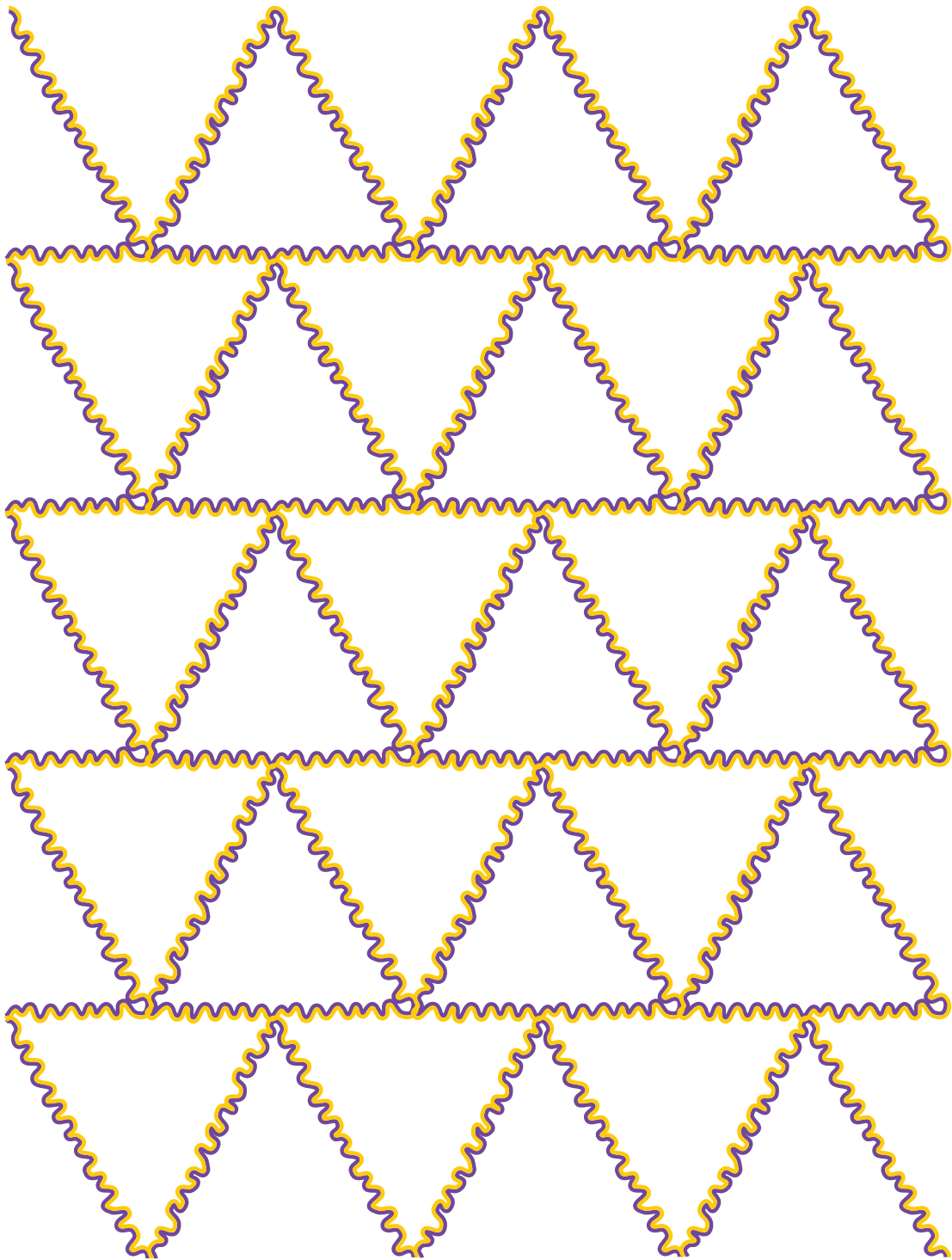

f

Figure 17. *Baingio Pinna*

Beyond the Gestalt principles of perceptual organization: The forms of grouping, shape and meaning

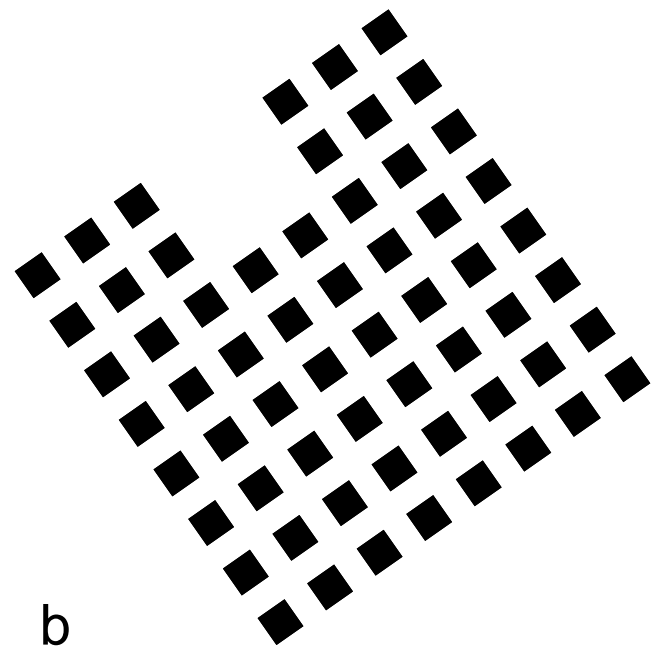
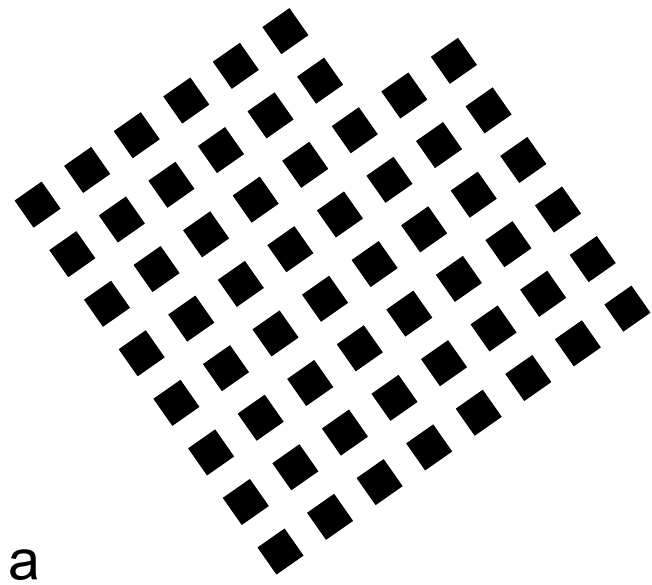

Figure 18. *Baingio Pinna*
Beyond the Gestalt principles of perceptual organization: The forms of grouping, shape and meaning

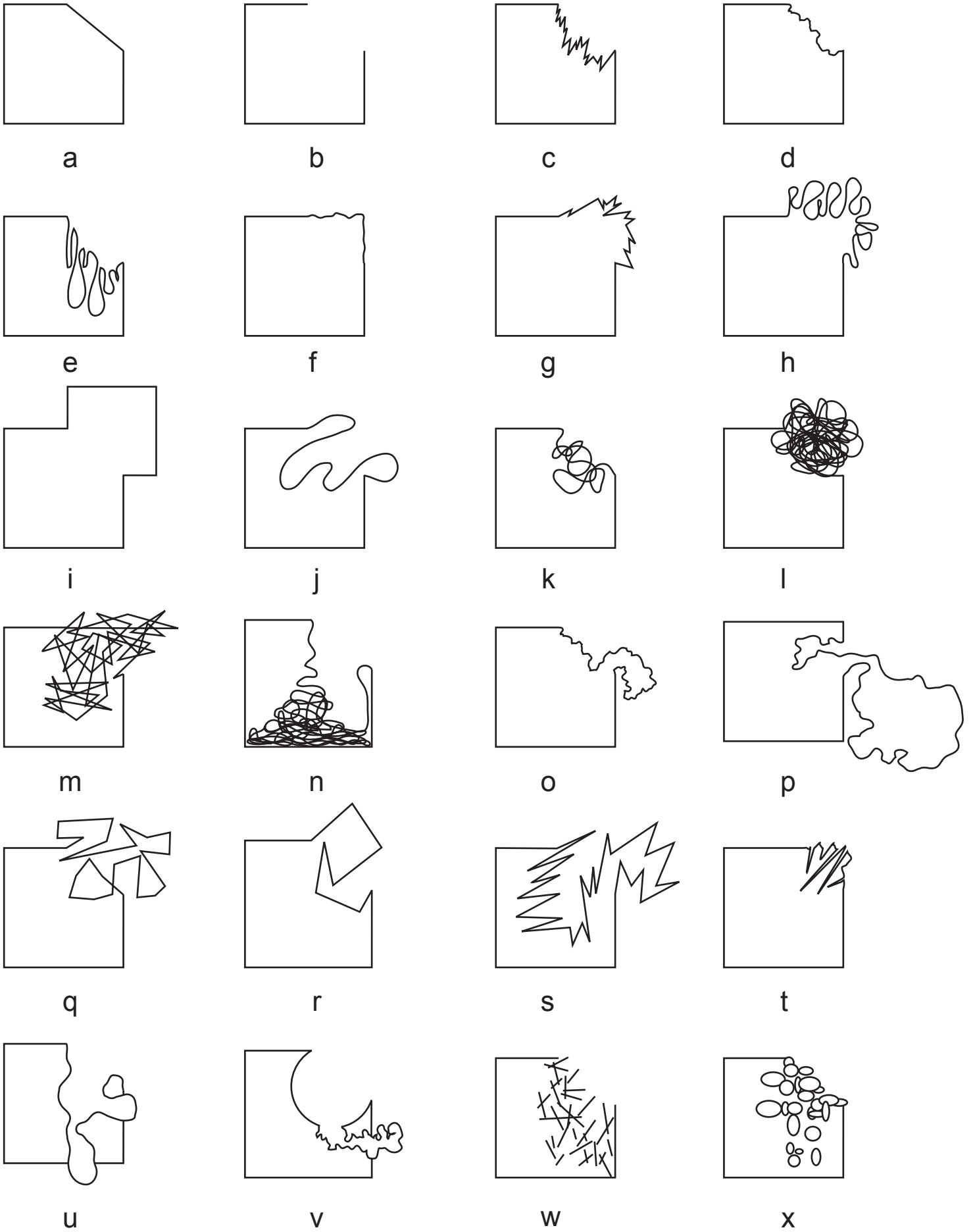
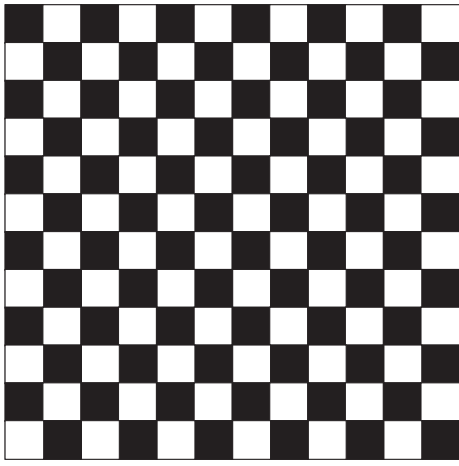
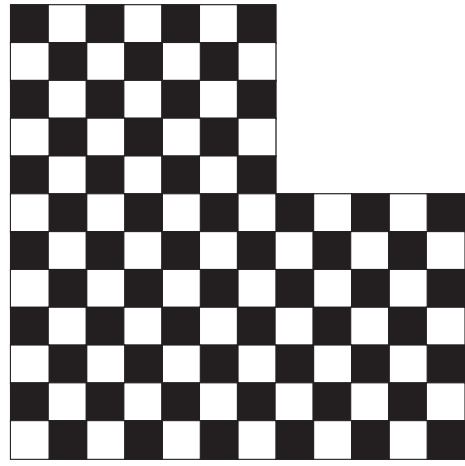

Figure 19. *Baingio Pinna*

Beyond the Gestalt principles of perceptual organization: The forms of grouping, shape and meaning



a



b

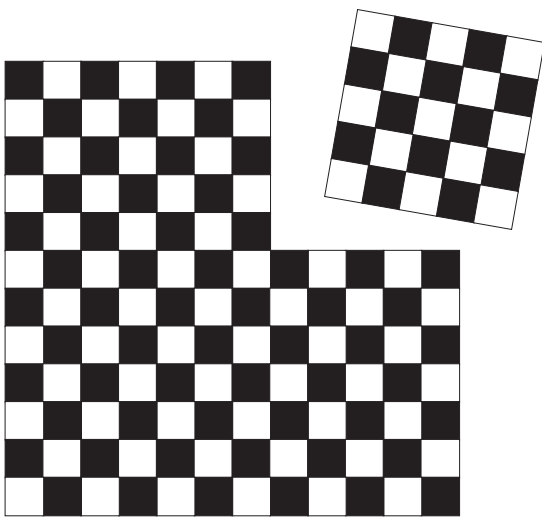

c

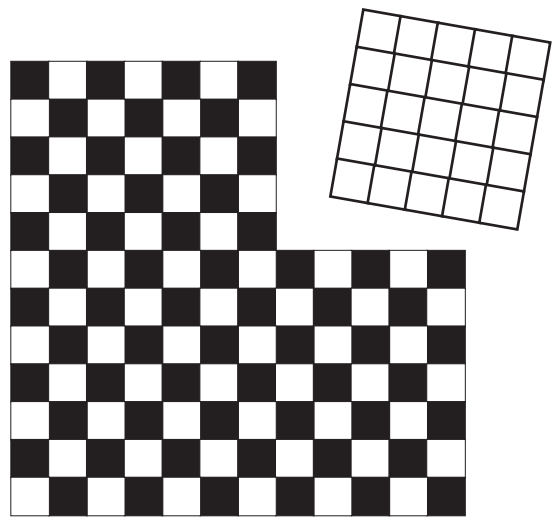

d

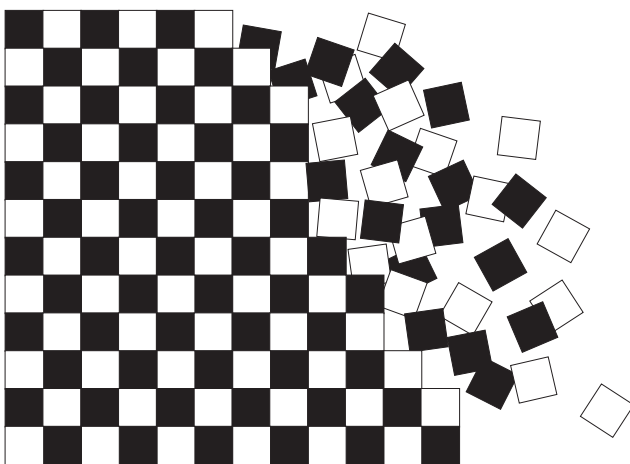

e

Figure 20. *Baingio Pinna*

Beyond the Gestalt principles of perceptual organization: The forms of grouping, shape and meaning

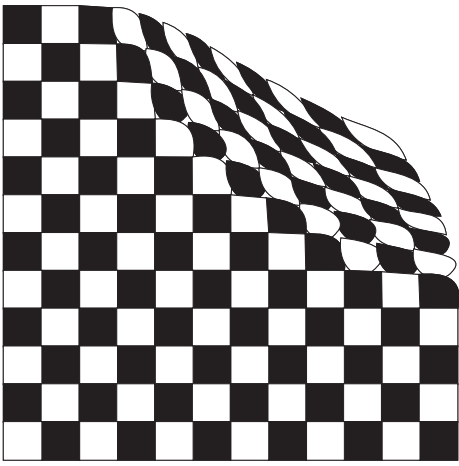

a

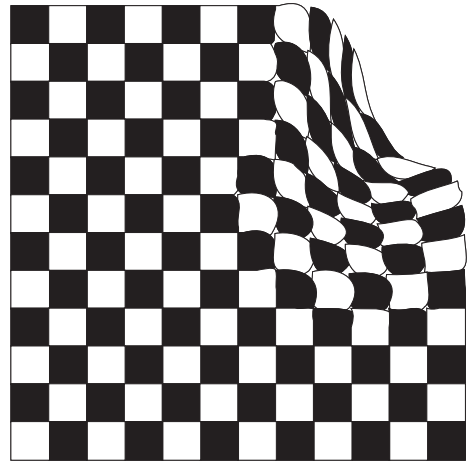

b

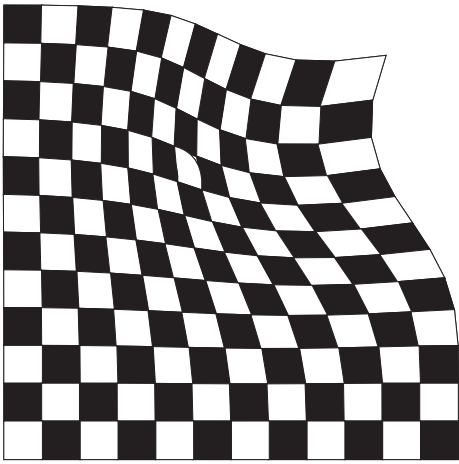

c

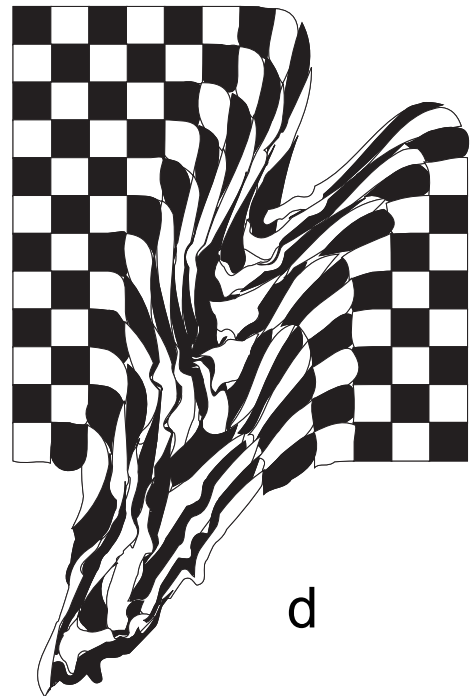

d

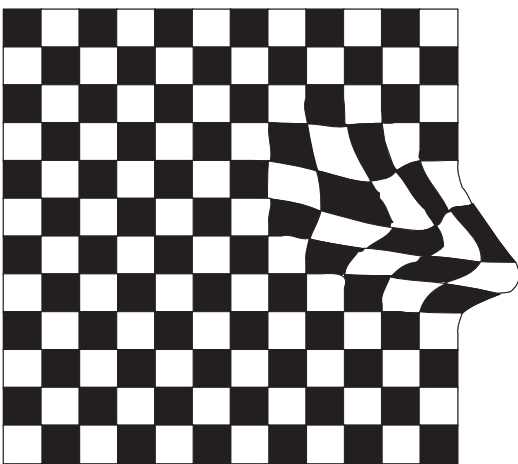

e

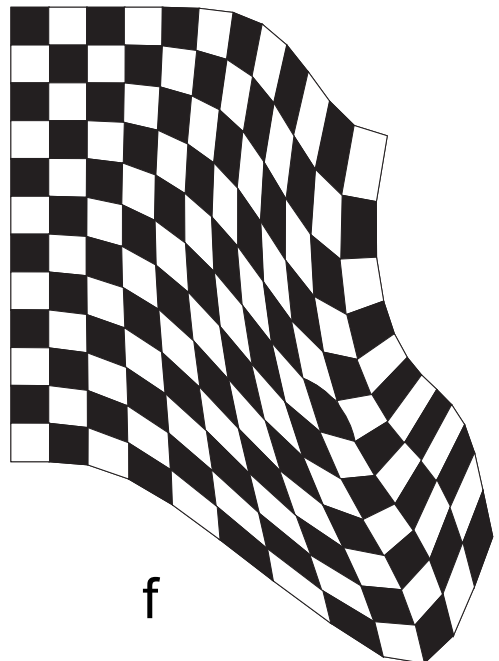

f

Figure 21. *Baingio Pinna*

Beyond the Gestalt principles of perceptual organization: The forms of grouping, shape and meaning

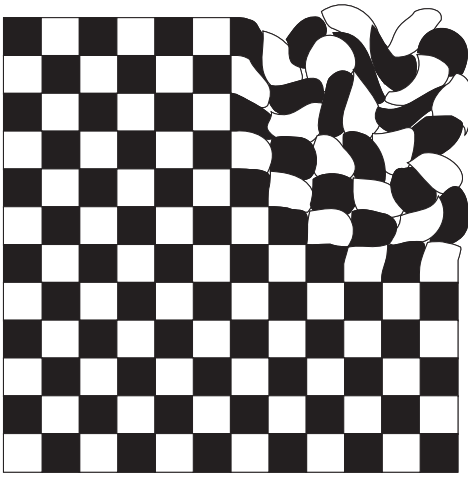

a

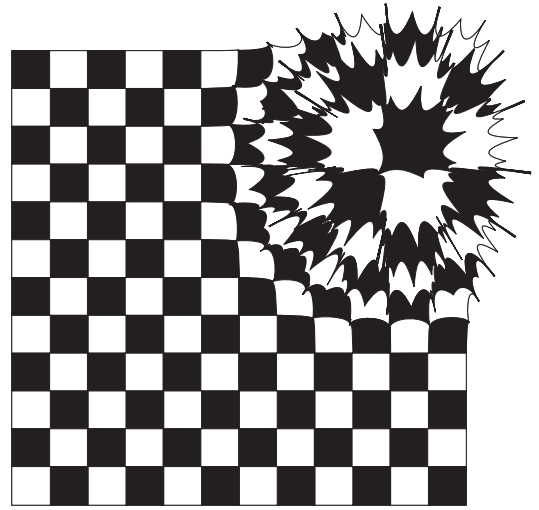

b

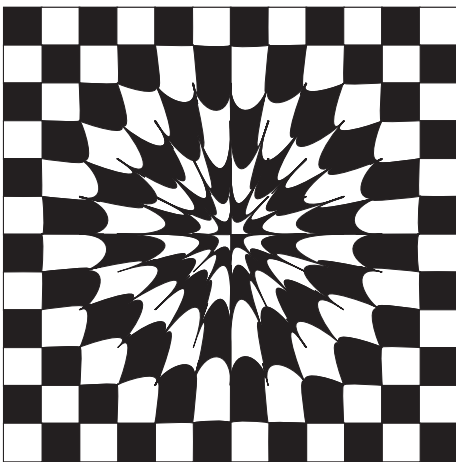

c

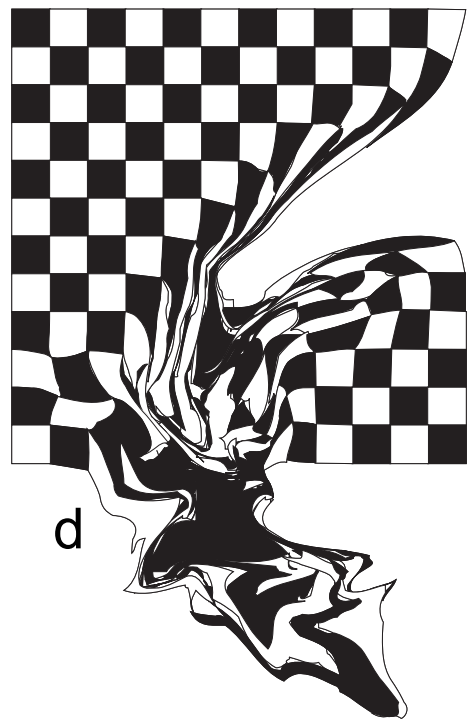

d



e



f

Figure 22. *Baingio Pinna*

Beyond the Gestalt principles of perceptual organization: The forms of grouping, shape and meaning

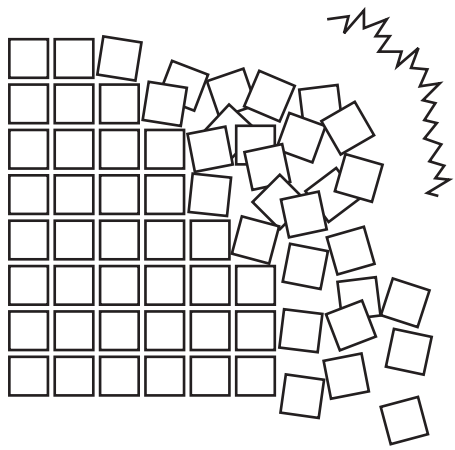

a

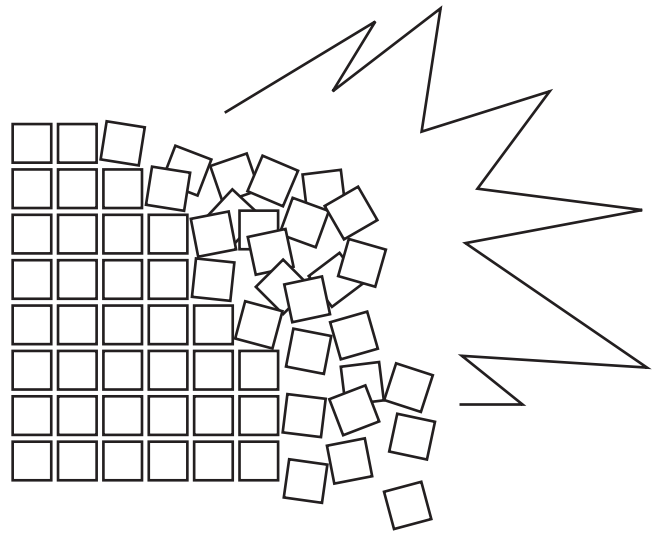

b

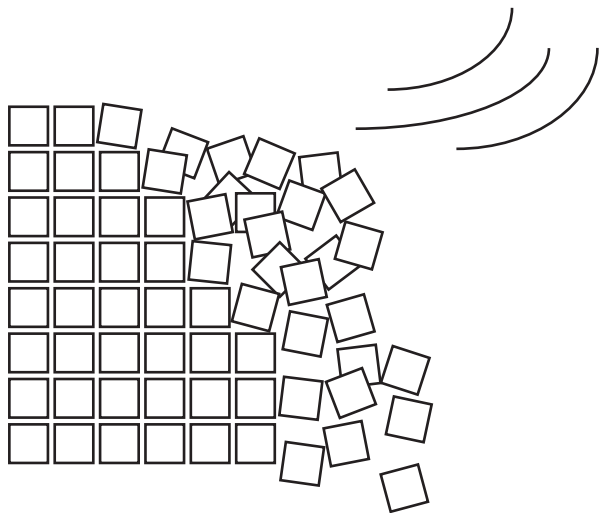

c

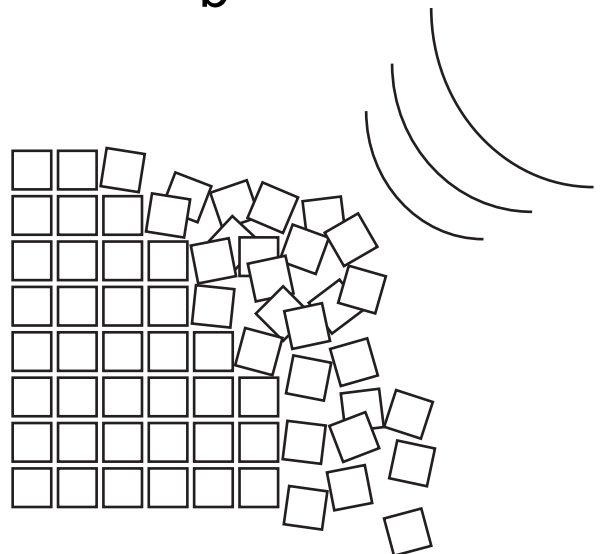

d

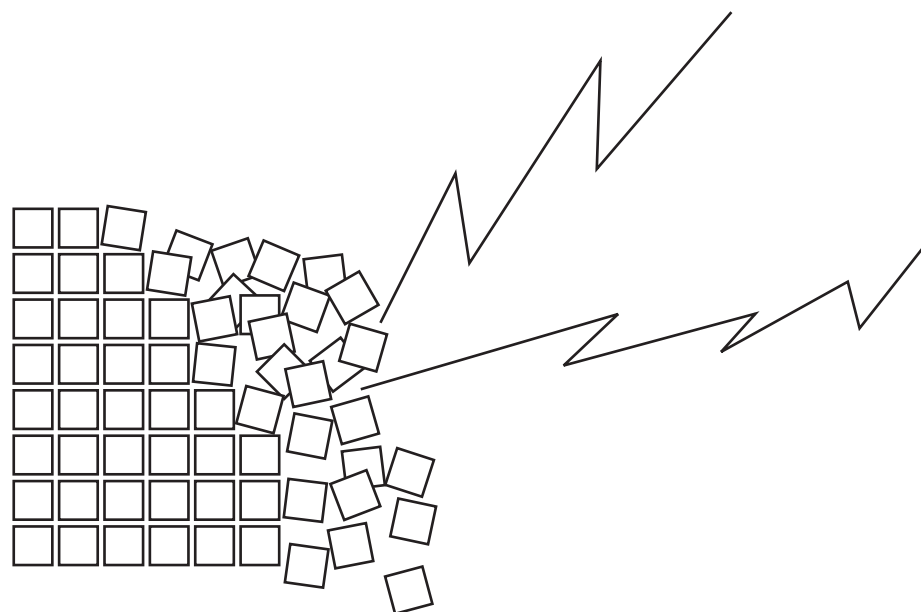

e

Figure 23. *Baingio Pinna*

Beyond the Gestalt principles of perceptual organization: The forms of grouping, shape and meaning

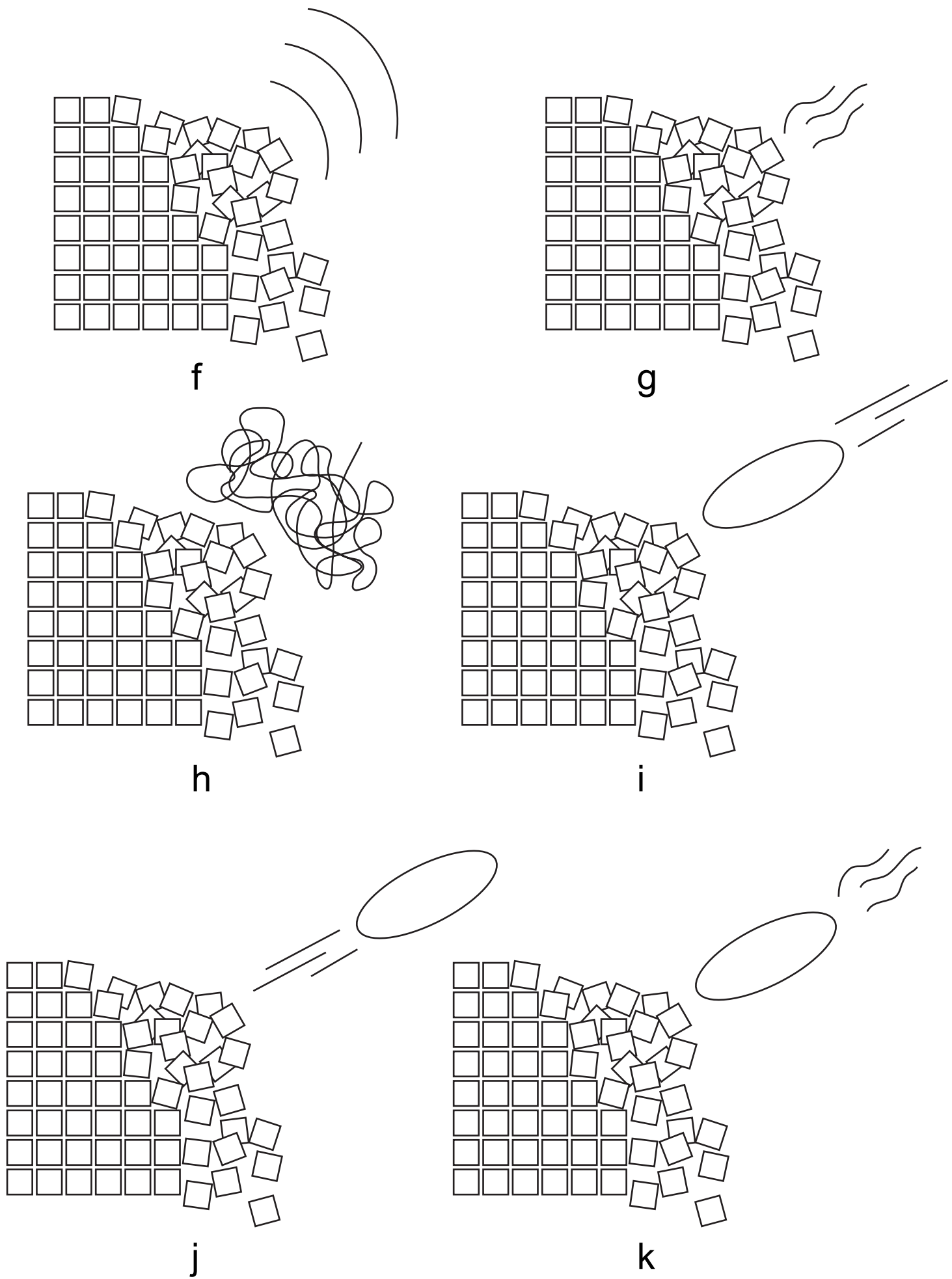

Figure 23. *Baingio Pinna*

Beyond the Gestalt principles of perceptual organization: The forms of grouping, shape and meaning